



Spaces

INSTALLATION GUIDE



CONTENTS

Tool List.....	03
Sub-Frame	04
Sub-Frame Support Advice.....	05
Sub-Frame Base	06
Sub-Frame Trims	07
Bottom Track	10
Decking	13
Walls.....	15
Roof Joists	25
Draining Edge Fascia	29
Roof OSB.....	31
Roof Membrane.....	32
Edge Trims	35
Soffits.....	36
Fascia.....	38
Windows and Doors	40
Floor Insulation	46
Floorboards.....	47
Ceiling Insulation.....	48
Ceiling Panels.....	49

PLEASE NOTE: Paperwork GRD001 - GRD0011 referred to within this guide are delivered with your Spaces kit.



TOOL LIST

ESSENTIAL TOOLS

- Drill
- Impact driver
- Spirit level
- Tape measure
- Rubber-headed mallet
- Nylon mallet
- Hammer
- Staple gun and staples
- Trimming knife
- Sealant gun – multiple of good quality recommended
- 13mm spanner
- Paintbrush/roller with a long handle
- Soft-bristled broom
- PVC saw
- Glazing shovel
- Putty knife/chisel
- Set of allen keys
- Wood saw
- Ladder
- Step-up
- Cleaning supplies – glass cleaner, solvent cleaner, PVC cleaner, rags, wipes, blue roll

DRILL BITS

- Pz1 bit
- Pz2 bit
- Pz3 bit
- Ph2 bit
- 10mm socket bit
- 5mm drill bit
- T15 bit



SUB-FRAME



TOOLS

Impact driver/drill

Pz3 socket bit

Spirit level

Tape measure

Mallet

COMPONENTS

Sub-frame timber (S*)

100mm sub-frame fixings

STEP 1

BUILD SUB-FRAMES

When assembling the sub-frame all joints are pre-drilled with two holes.

For fixing the sub-frame, use 2 x 100mm sub-frame fixings.

- 1 Lay out joists according to paperwork (GRD001).



- 2 Fix "C" shape together by aligning all joists with pre-drilled holes.

NOTE: Ensure the top face of all timbers are flush.

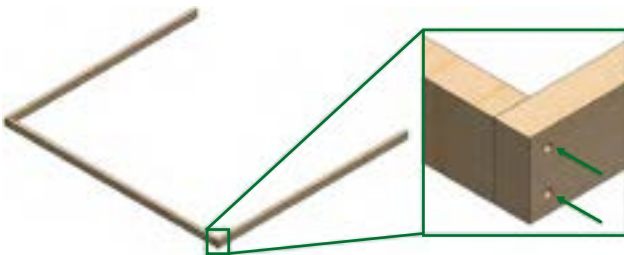

- 3 Fix the first row of noggings.

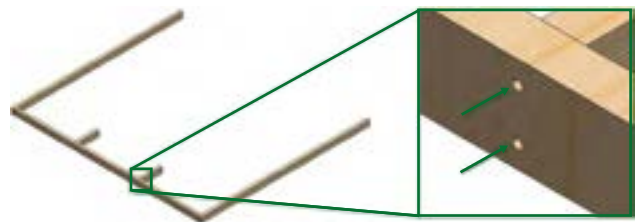

- 4 Fix second joist into place.

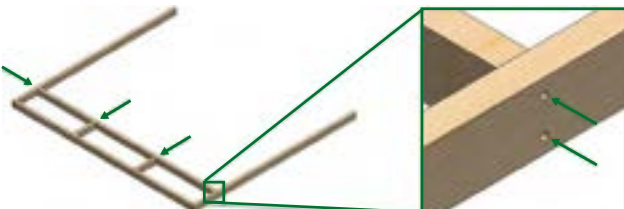

- 5 Repeat until you reach the last set of noggings. Cut to suit where required and fix into place.

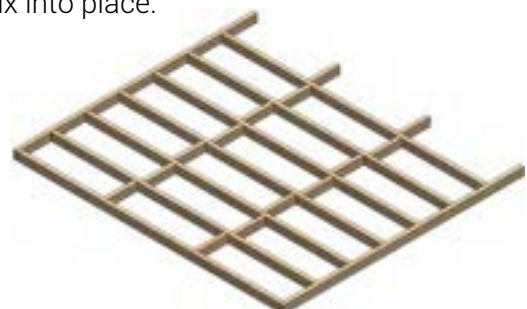



SUB-FRAME

6 Ensure the sub-frame isn't bowing and is square when the final joist is laid in position.

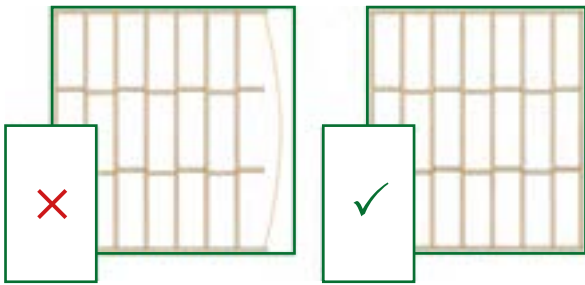

7 Screw the final joist into place and fix into the noggings to complete the sub-frame.

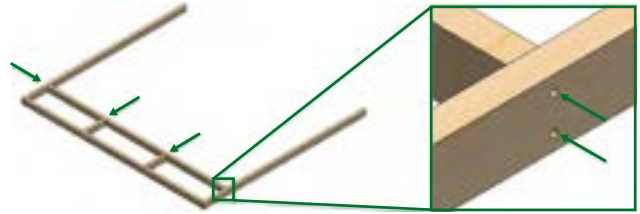

STEP 2 FIXING SUB-FRAMES TOGETHER

Only applicable when multiple sub-frames are required.

8 In instances where there are multiple sub-frames, they will need fixing together. Build both frames as shown in Step 1.



9 Align the top of the timbers flush and fix the sub-frames together using 2 x 100mm sub-frame fixings in pairs at 600mm centres along length of the joist.

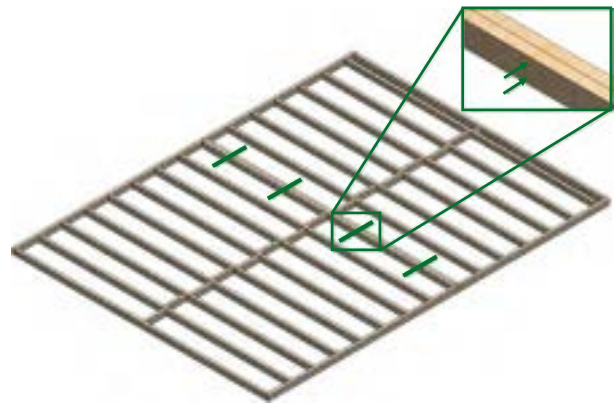

SUB-FRAME SUPPORT ADVICE

It is important that your sub-frame is elevated a minimum of 25mm from the ground to prevent the timber from sitting in water and to allow for air-flow.

We recommend supporting your sub-frame at 1200mm intervals and along every other joist, ensuring the perimeter of the sub-frame is supported.

It is also vital to ensure your sub-frame is level and square, so that your garden room has a level foundation.

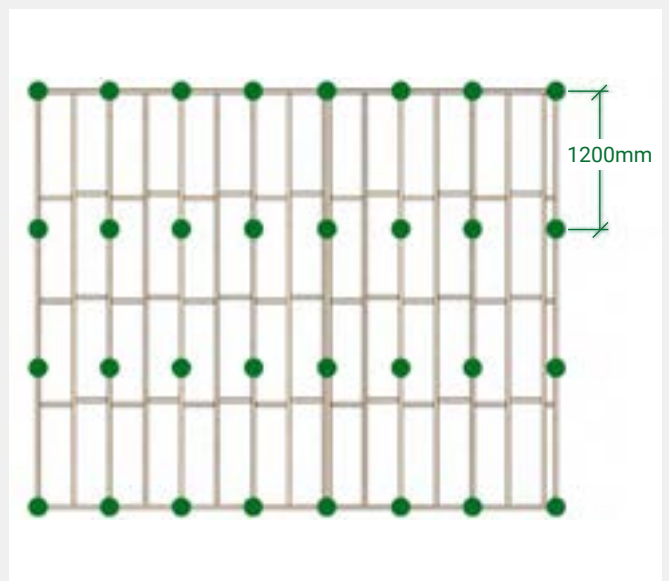



SUB-FRAME BASE



TOOLS

Impact driver/drill

Pz2 bit

Staple gun

Trimming knife

COMPONENTS

18mm OSB (B*)

Vapour barrier

5 x 50mm wood screws

STEP 3

FIXING DOWN SUB-FRAME BASE

- 1 Lay out vapour barrier over joists, ensuring the printed side is facing down. Pin in place with a staple gun.

NOTE: The vapour barrier is only required underneath the OSB. Ensure you only cover this area.

NOTE: Do not trim vapour barrier at this step.



- 2 Lay out your first OSB sheet onto the sub-frame according to paperwork (GRD002).

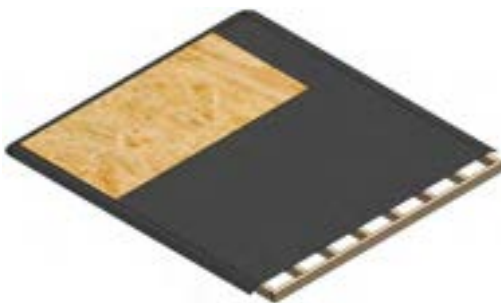

- 3 Fix down OSB using 50mm wood screws at 600mm centres and into all joists. Fix around the perimeter of the board too.

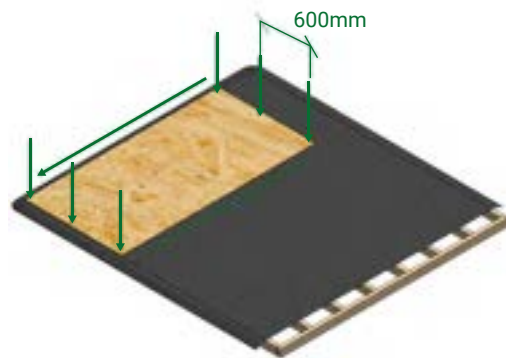

- 4 Repeat this process for the rest of the OSB sheets.



- 5 Trim vapour barrier around all sides of the OSB.

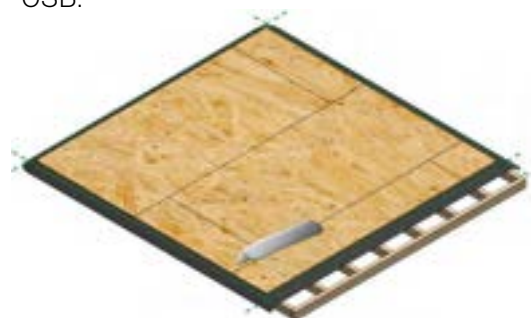



SUB-FRAME TRIMS



TOOLS

Impact driver/drill

Pz1 bit

Sealant gun

Tape measure

Hammer

COMPONENTS

Adhesive

Superglue

3mm x 30mm
wood screws

Sub-frame trim (L*)

Step trim (T*)

Step trim end cap

STEP 4

FIXING DOWN SUB-FRAME TRIMS

Edges where the deck boards are to be fitted will have a step trim. All other edges will have sub-frame trims.

Each trim has its own corresponding code and number on the paperwork (GRD003).



Sub-Frame Trim L*



Step Trim T*

L-TRIM TO L-TRIM

- 1** Fit one sub-frame trim, making sure to dam the edge with adhesive.



- 2** Fit the second sub-frame trim, ensuring the mitres are tight.



- 3** Seal the outer edge with adhesive and wipe clean.



- 4** Position step trims as shown on paperwork (GRD003).

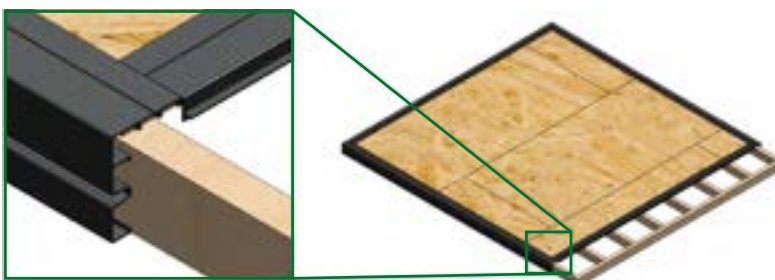

- 5** Dam the step trim with adhesive.





SUB-FRAME TRIMS

L-TRIM TO STEP TRIM

6 Fit the step trim, ensuring the joints are tight.

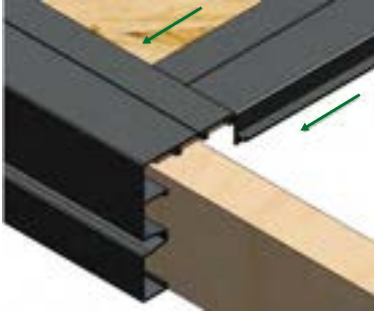

7 Seal the outer edge and wipe clean.



8 Seal and dam up the end caps using adhesive and insert into the sub-frame trims.

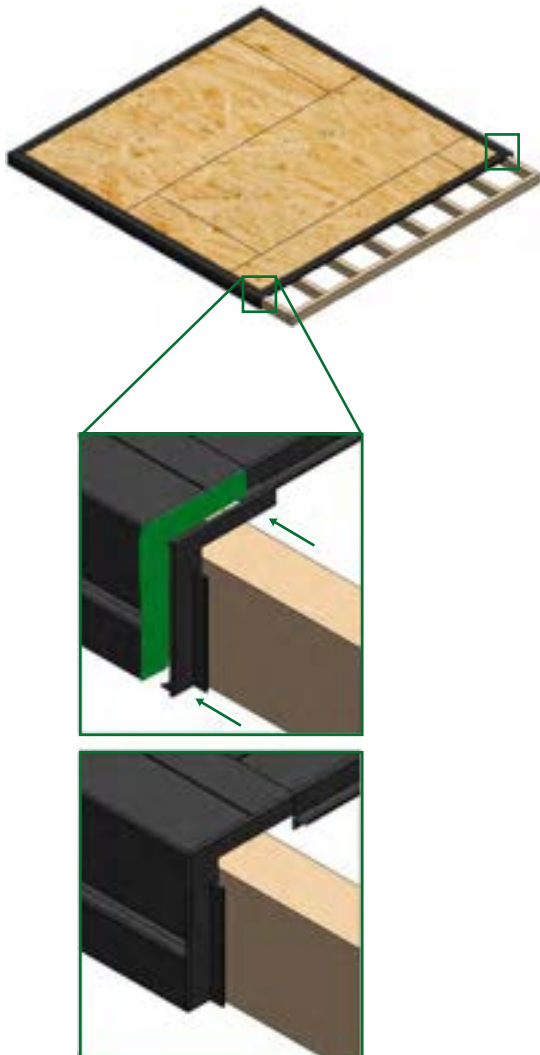

9 Consult paperwork (GRD003) and position your first trim on the front edge of the sub-frame. Centralise and fix down using 3mm x 30mm wood screws.





SUB-FRAME TRIMS

L-TRIM TO STEP TRIM

10 Position the rest of your trims and check the diagonals.

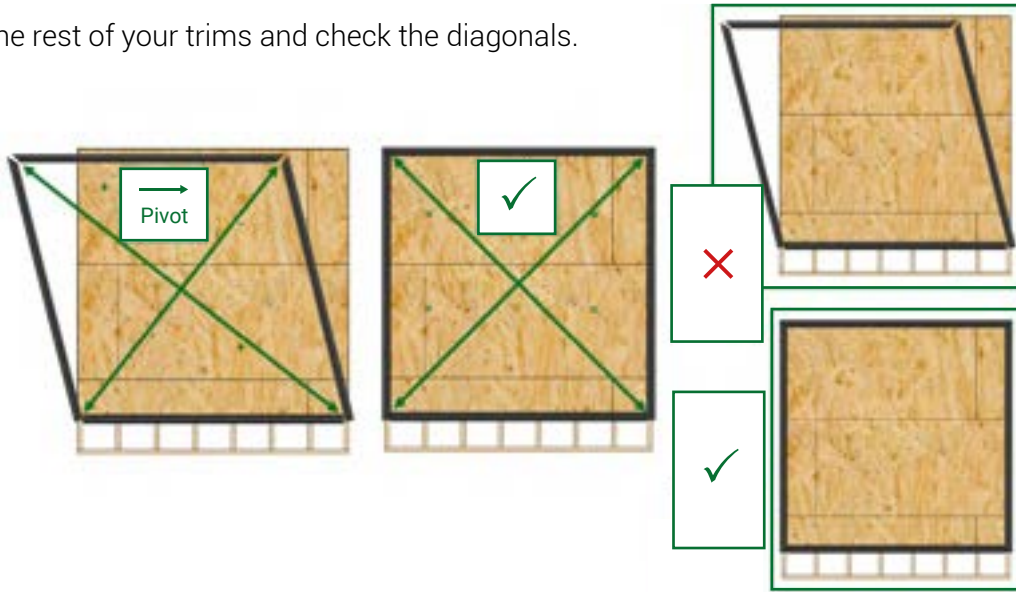

11 Square up and fix all trims down into pre-drilled holes using 3mm x 30mm wood screws.

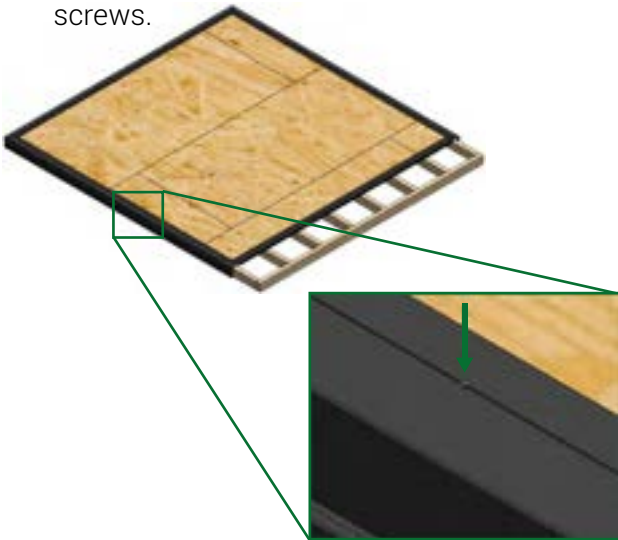

12 Seal all screw heads using adhesive.

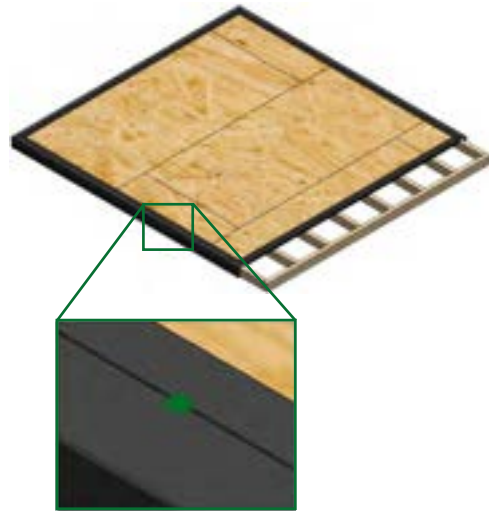

13 Fix the architrave around the sides using an appropriate adhesive or PVCu nails at 400mm centres, and then fix the front architrave.



14 Attach the corner mouldings to each corner of the step using superglue.

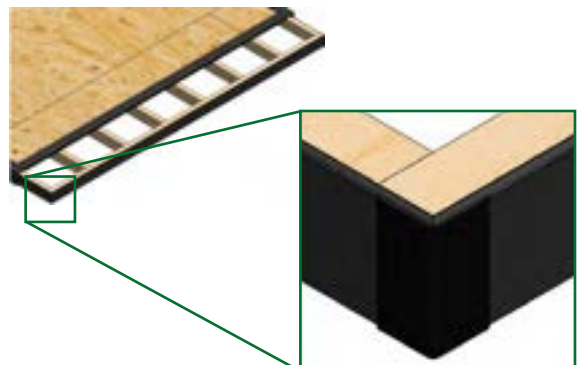



BOTTOM TRACK

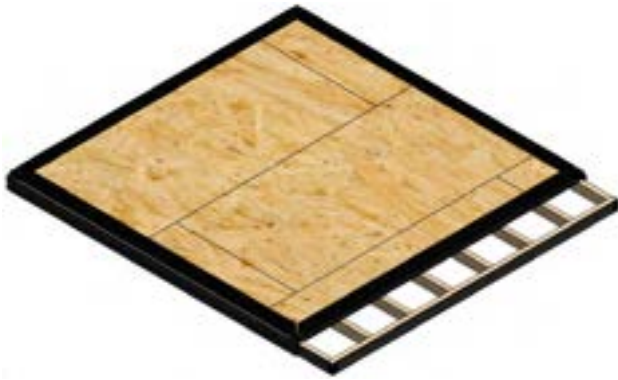

TOOLS

- Drill
- Sealant gun
- Tape measure
- Pz2 bit
- 5mm drill bit

COMPONENTS

- Bottom track (BT0*)
- Corner moulding
- Adhesive
- 5mm x 70mm wood screws

STEP 5

SEALING AND FIXING DOWN BOTTOM TRACK

- 1 Find the bottom track that corresponds with the front edge according to paperwork (GRD004). Seal with adhesive and then slide a corner moulding into the front bottom track at both ends.

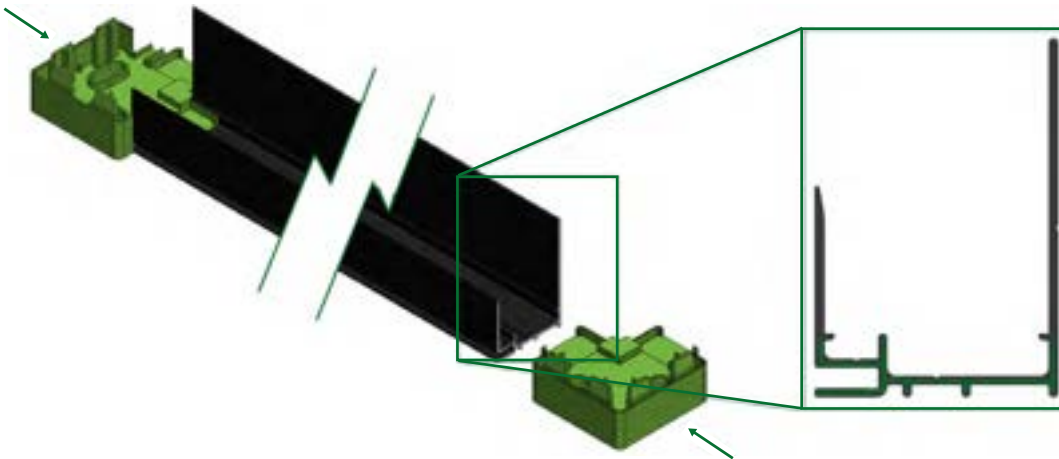

- 2 Run a bead of adhesive across the width of the sub-frame trim, making sure you follow the groove as you go.



NOTE: Seal along the entire length of the track.

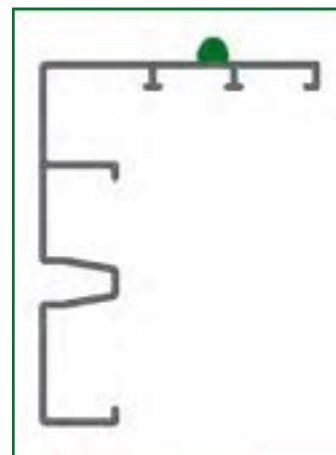



BOTTOM TRACK

- 3** Turn track over and centralise from left to right, and position as shown below.



STEP/DECKING EDGE

Position 5mm from the edge.



NO STEP/DECKING EDGE

Position 20mm from the edge.

- 4** Pre-drill holes using a 5mm bit. Fix corner mouldings into place using one 70mm wood screw at each end of the front track.

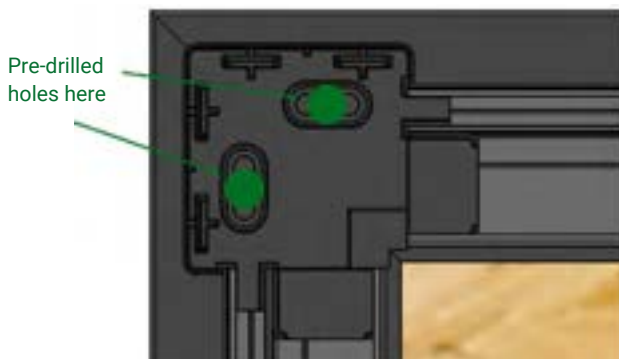

- 5** Seal the rest of the tracks as shown on steps 1 and 2 – slot together and roughly position the rest of the tracks.

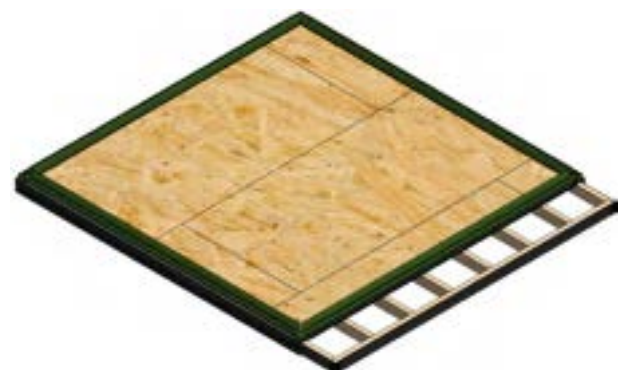



BOTTOM TRACK

- 6 Adjust the tracks until the diagonal measurements are equal.

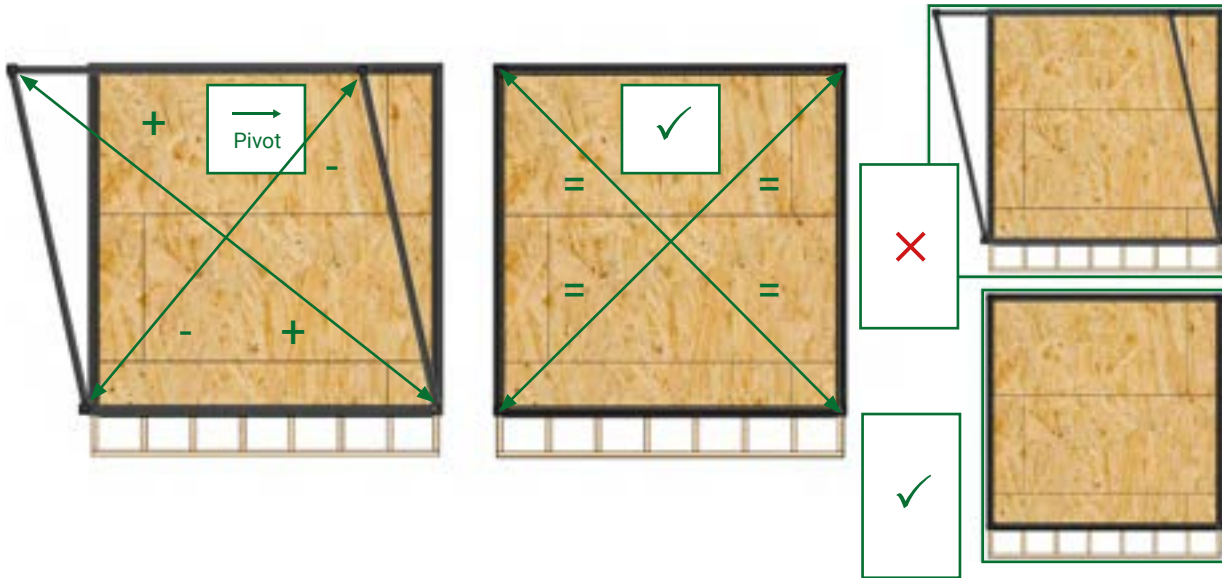

- 7 Fix down the rest of the corner mouldings using the same method as Step 4.

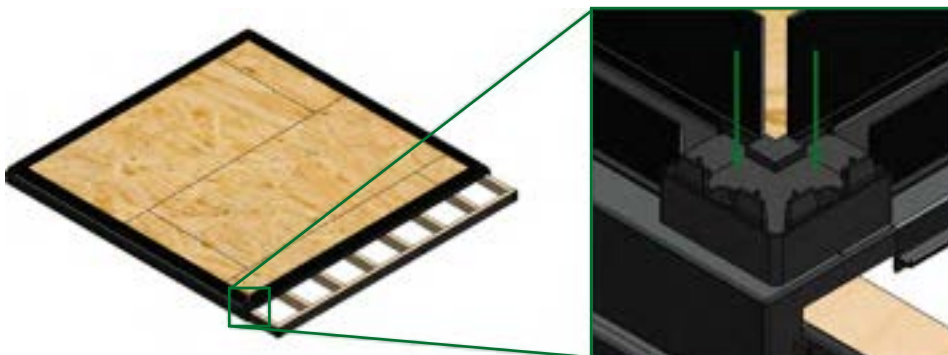

- 8 Run a 5mm drill bit through all the pre-drilled holes in the bottom tracks. This will pierce through the bottom sub-frame/step trim to allow for fixing. Fix down with 5mm x 70mm screws and seal the screw heads with adhesive.

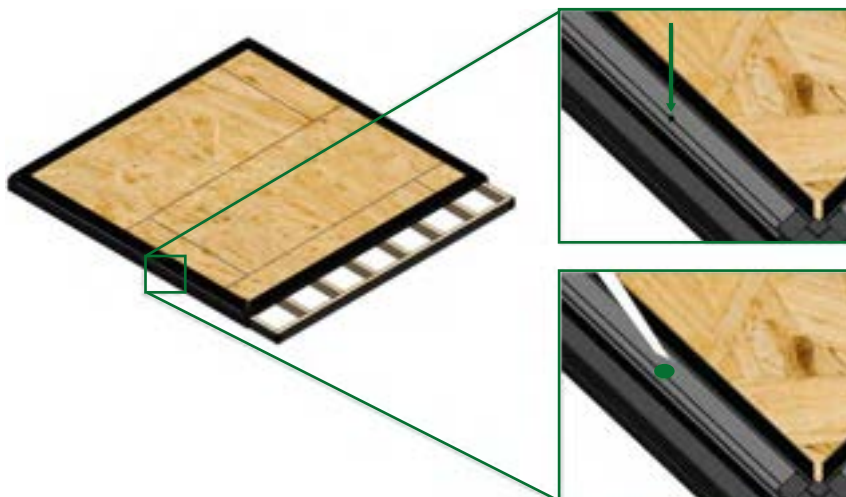



TOOLS

- Impact driver/drill
- T15 bit
- Rubber headed mallet

COMPONENTS

- Deck boards
- T-clips
- Hidden fixing kit
- SBU side trim
- Decking L-Trim
- Superglue and activator

STEP 6 INSTALL DECKING

- 1 Slide the first deck board into the step trim. Ensure you are using a board without a side trim clipped into it.



NOTE: You may have to tap the deck board into place using a mallet and a block of wood to ensure you don't damage the deck board.

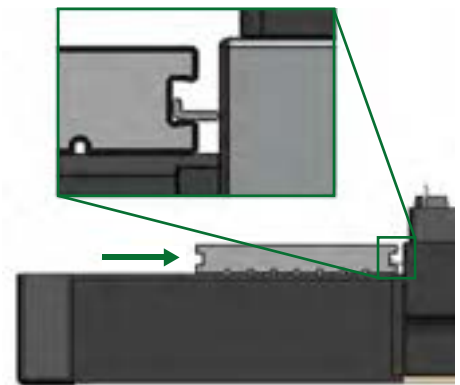

- 2 Centralise the deck board and fix down using T-Clips into every joist.

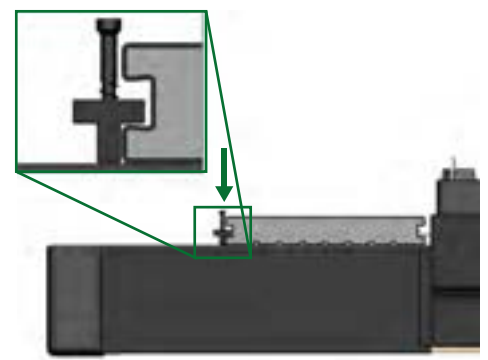

- 3 Push the next board up to the T-Clips.



NOTE: You may have to tap the deck board into place using a mallet and a block of wood to ensure you don't damage the deck board.

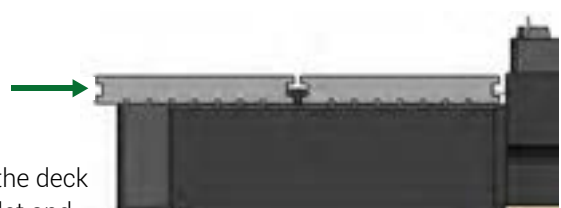



DECKING

- 4 Repeat until you reach the last board. Ensure you are using the board with the Switchboard Ultra Side Trim clipped into it, and that the clip side is facing away from the building.

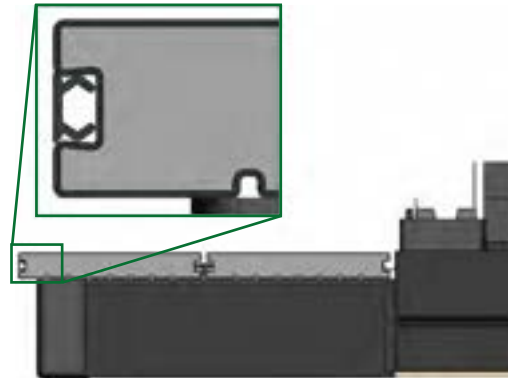

- 5 Fix the final edge using hidden fixings at 400mm centres. Use the provided bit with the stopper to ensure screws are at the correct depth.

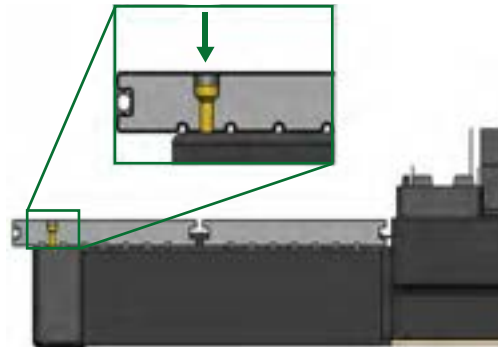
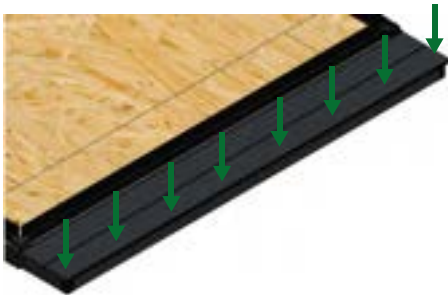

- 6 Tap the hidden fixing plugs with a rubber headed mallet into all the cavities to cover screw heads.

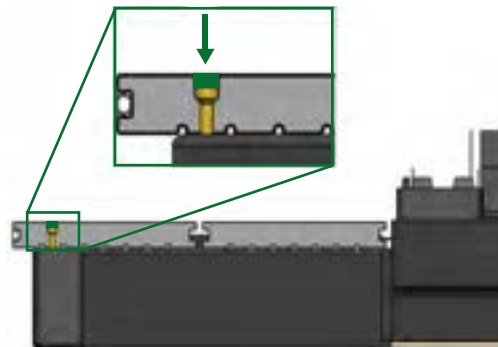
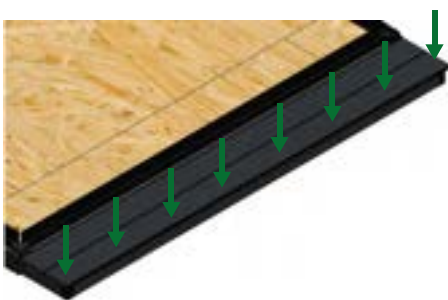

- 7 Fit the Deck Board L-Trim onto the cut ends of the decking with adhesive.

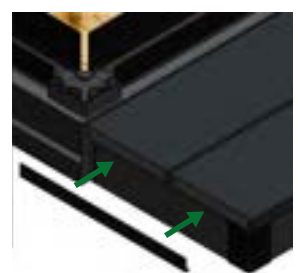
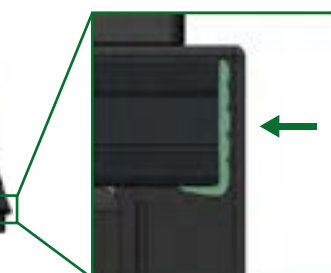



TOOLS

- Impact driver/drill
- Ph2 bits
- Rubber headed mallet
- Sealant gun
- Level
- Ladder/step-up

COMPONENTS

- Wall panel (WP0*, NWP0*)
- Corner assemblies (CA01)
- Top track (TT0*)
- Adhesive
- Pinch clips
- 30mm PVCu screws

STEP 7

INSTALLING WALLS

Consult paperwork (GRD005) to see where wall panels, corner assemblies, windows and doors are located. Take note of the positions of notched wall panels and corner assemblies.

Start installing the walls from the recommended point shown on the paperwork (GRD005).

This section is divided into six parts. The order of installation will depend on your building configuration:

A INSTALLING THE FIRST CORNER ASSEMBLY

B INSTALLING THE STANDARD WALL PANELS

C INSTALLING THE OPENING SURROUNDS

D INSTALLING THE SECONDARY CORNER ASSEMBLIES AND THE TOP TRACK

E FIXING OPENING SURROUNDS

F INSTALLING THE FINAL WALL PANEL



A INSTALLING THE FIRST CORNER ASSEMBLY

- 1 Apply a continuous bead of adhesive to the bottom track and corner moulding within 350mm of the first corner as shown below.

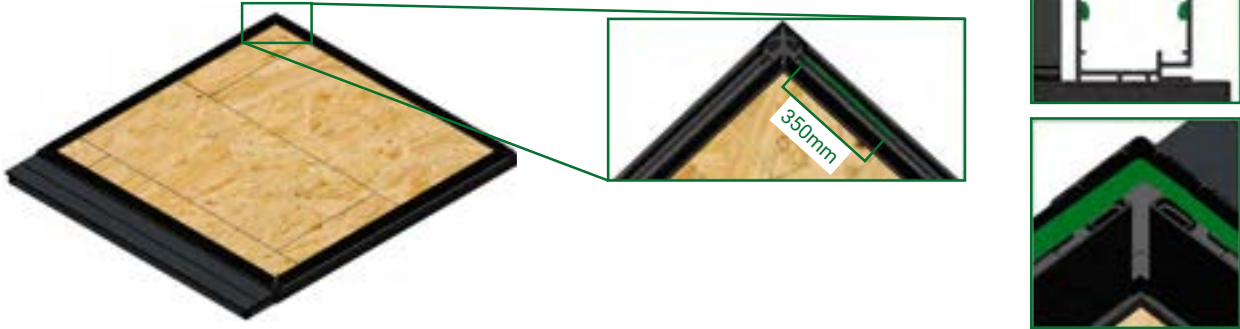

- 2 Slide a pinch clip onto the end of the wall panel and corner post.

NOTE: Post protrudes at the top end of the board only.

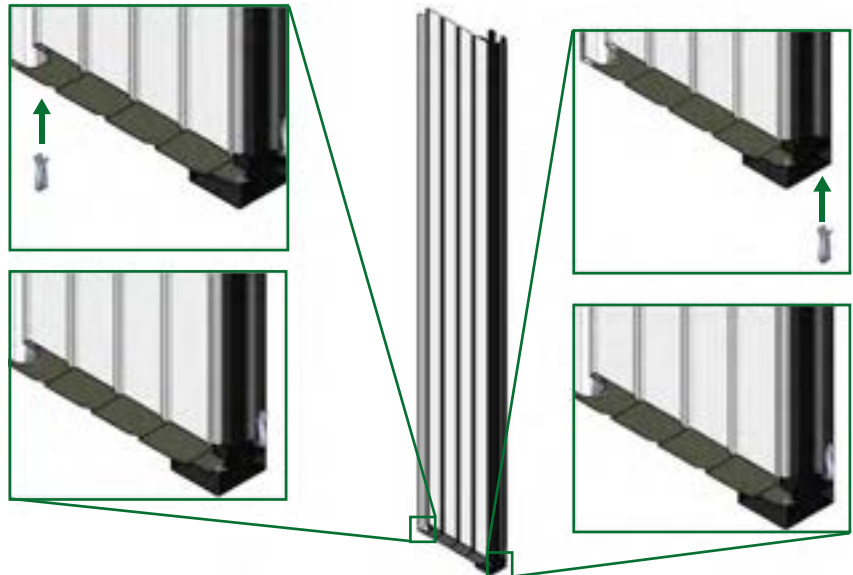

- 3 Insert "corner assembly" into the bottom track.



- 4 Check that the wall is plumb.



- 5 Once plumb, screw the corner assembly in place through the pre-drilled hole in the bottom track using a 30mm PVCu screw.

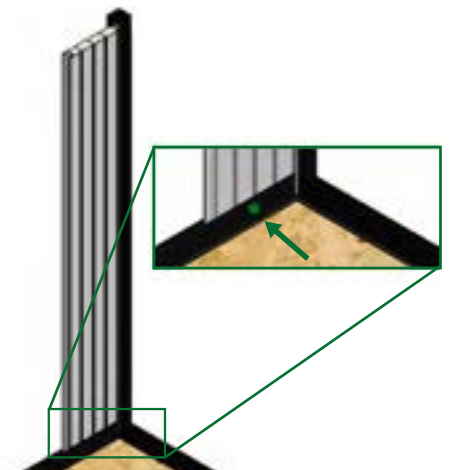



B INSTALLING THE STANDARD WALL PANELS

- 6** Pre-insert pinch clips onto the bottom of all your panels and remove the protective tape from both sides prior to inserting them into the track.

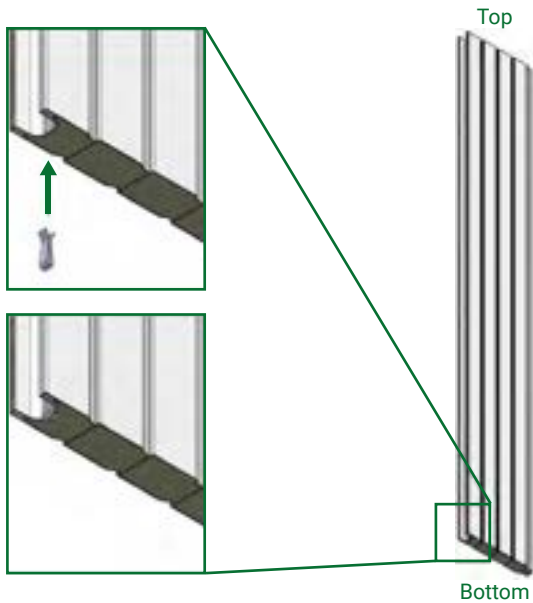

- 7** Run two continuous beads of adhesive along the entire length of the bottom track.

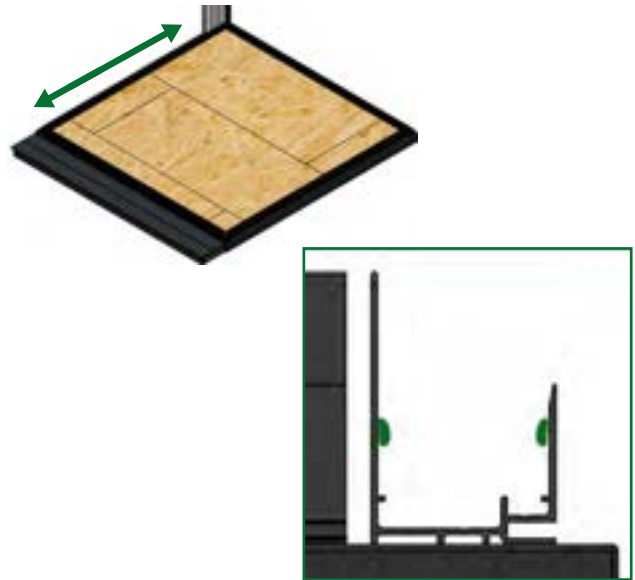

- 8** Slot the next panel into the track, ensuring pinch clips are placed at the bottom of the panel you are sliding in. Use the slide/engage motion as shown below to ensure the panel securely clips into place.

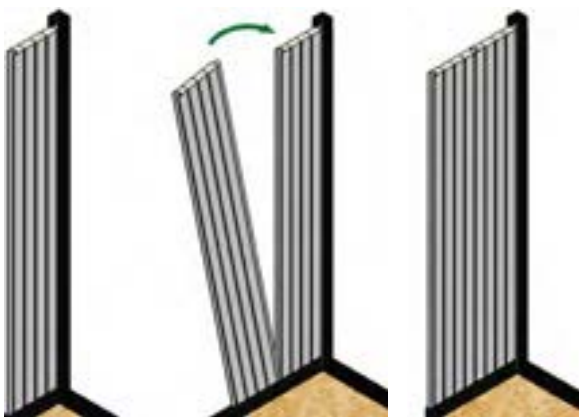

- 9** A pinch clip must be inserted at the top of the panel to secure in place.

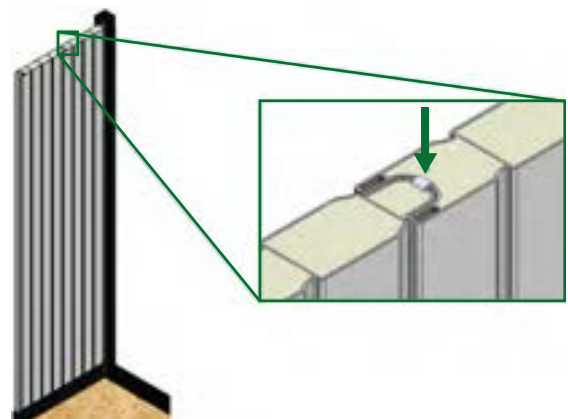

- 10** Install the rest of your wall panels, ensuring pinch clips are inserted top and bottom, until:

You reach the position of a window or door, see page 18.
(C Installing the Opening Surrounds)

Or, you reach the next corner assembly, see page 21.
(D Installing the Secondary Corner Assemblies and the Top Track)



WALLS

C INSTALLING THE OPENING SURROUNDS

11 Apply a bead of adhesive to the length of the soldier.

NOTE: Run two continuous beads of adhesive along the entire length of the bottom track also.

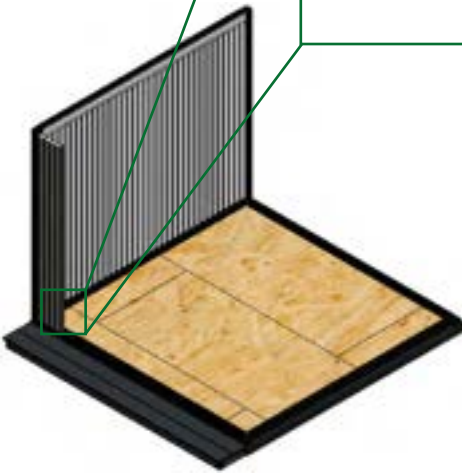
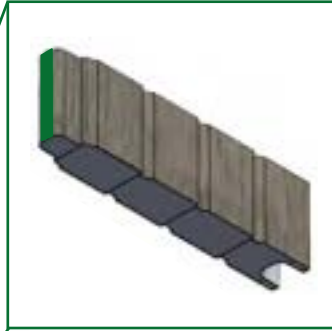

12 Insert the bottom row of soldiers according to paperwork, ensuring they are secured by pinch clips at the top and bottom.

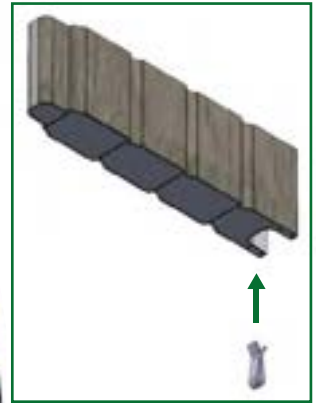
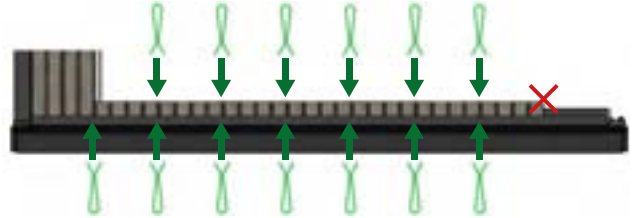

13 Apply two continuous beads of adhesive onto the opening surround as shown below, and then slot into position.

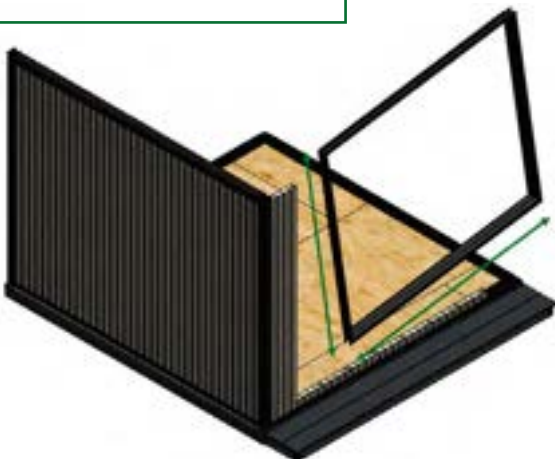

14 Ensure that the surround is fully located into the wall panel along the left and the bottom sides.





WALLS

C INSTALLING THE OPENING SURROUNDS

15 Apply two continuous beads of adhesive onto the opening surround as shown below.

NOTE: Ensure that the adhesive spans the entire length of the surround.

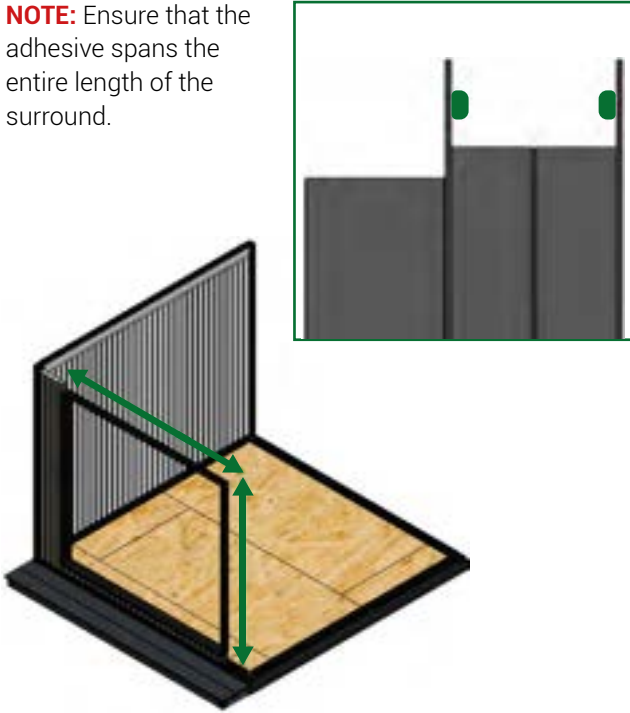

16 Apply adhesive where shown below.

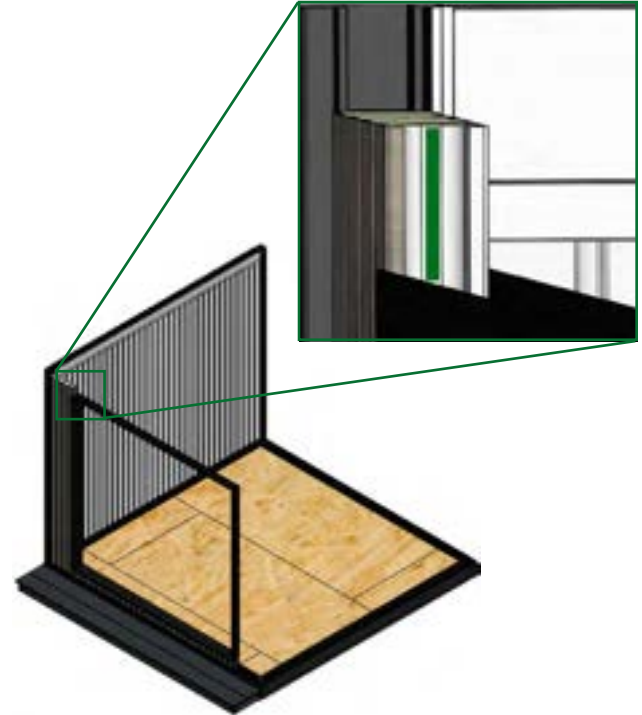

17 Insert the top row of soldiers, ensuring they are secured by pinch clips at the top and bottom.

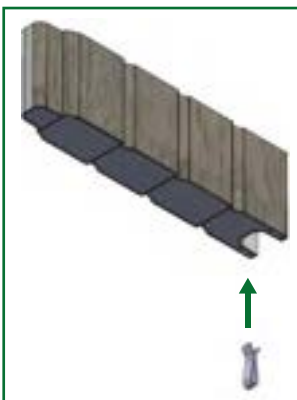
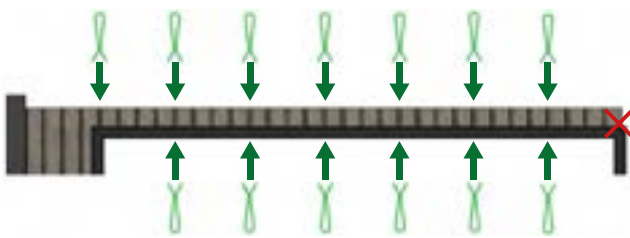

18 Apply adhesive where shown below.

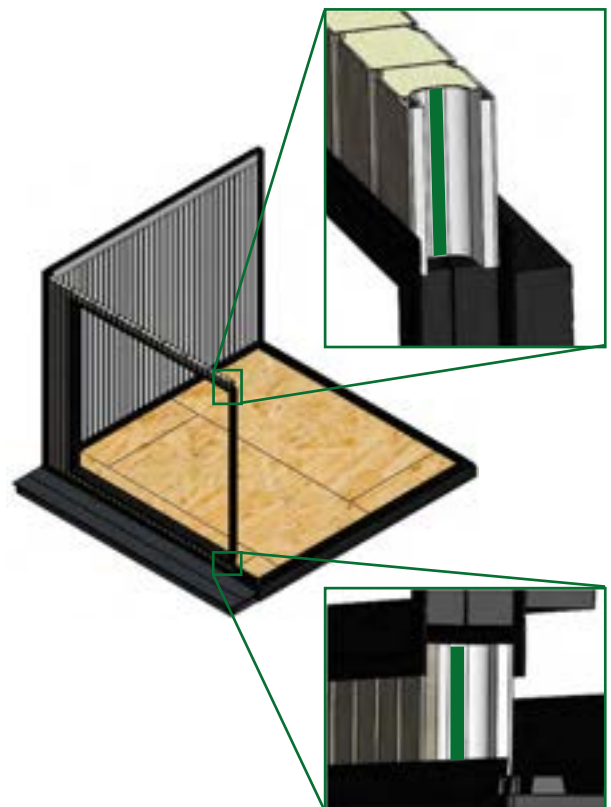



C INSTALLING THE OPENING SURROUNDS

19 Slide the notched wall panel into place.



20 Insert a pinch clip between the final soldier and notched wall panel.

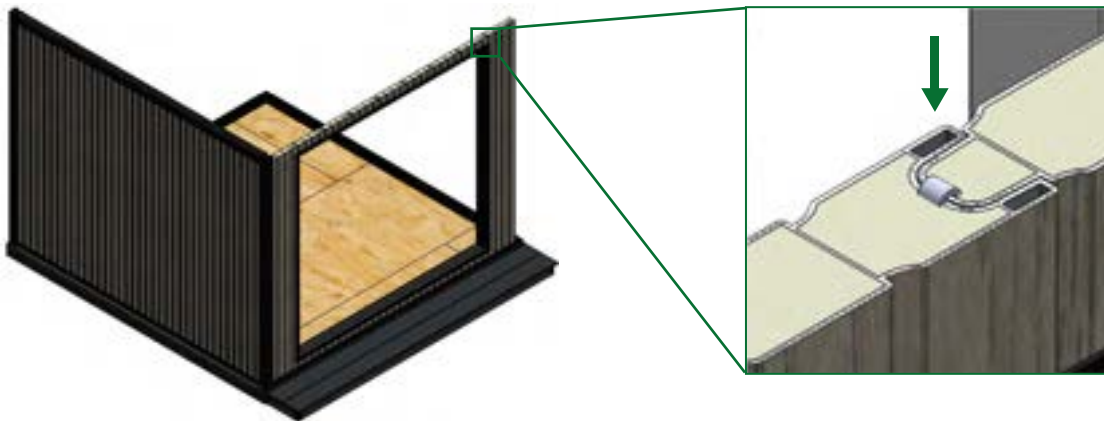

D INSTALLING THE SECONDARY CORNER ASSEMBLIES AND THE TOP TRACK

21 Apply adhesive inside the bottom track and corner moulding.

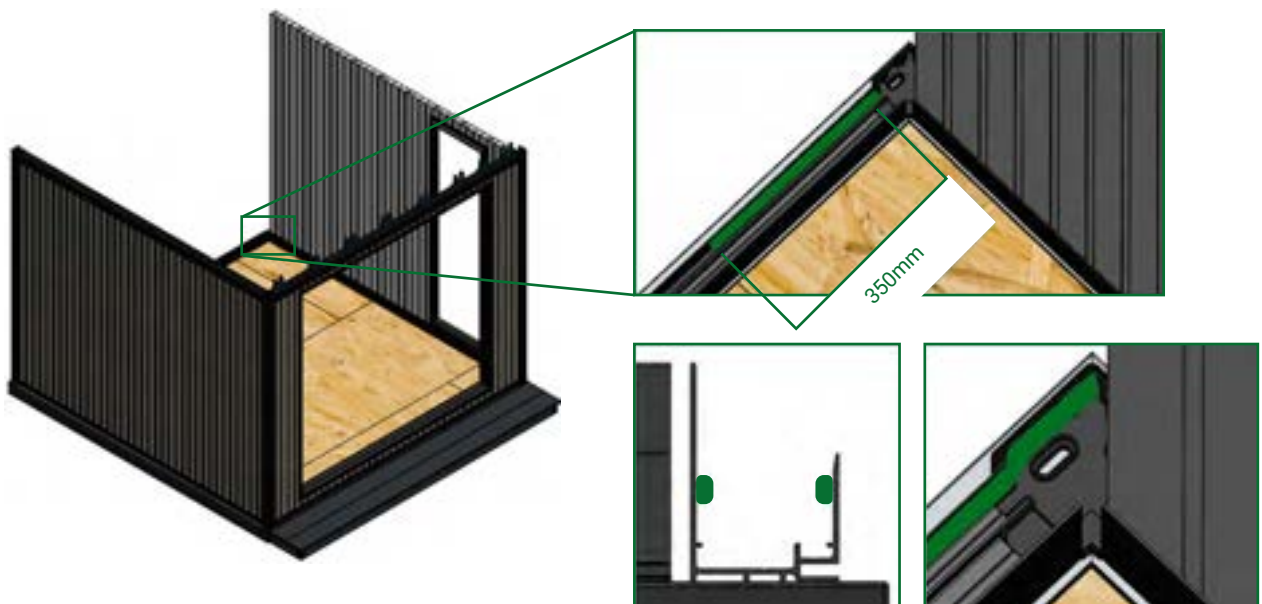



D INSTALLING THE SECONDARY CORNER ASSEMBLIES AND THE TOP TRACK

- 22** Slide pinch clips onto the bottom female end of the wall panels.

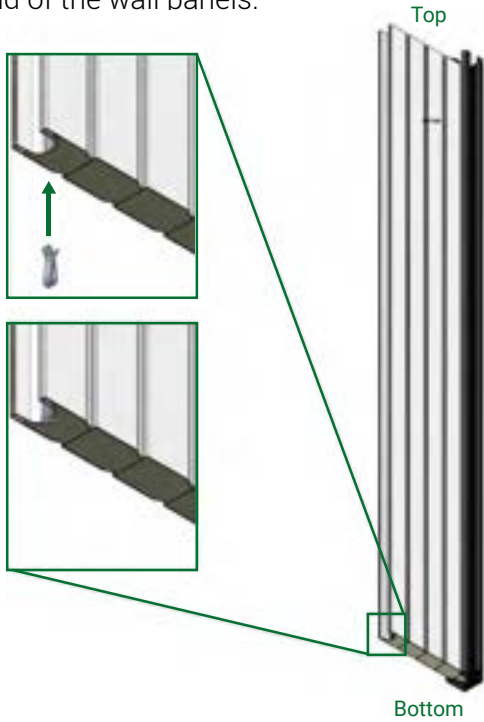

- 23** Run a bead of adhesive down the entire length of the male end of the corner post.

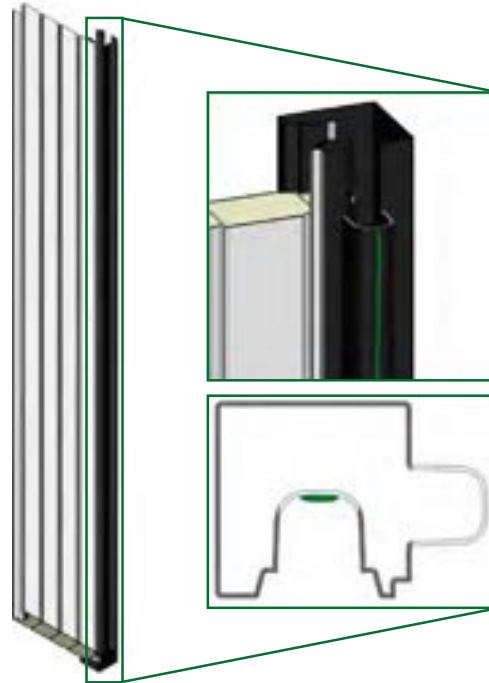

- 24** Install the next wall panel, ensuring it engages with the pinch clips.



- 25** Check that the wall is plumb.





D INSTALLING THE SECONDARY CORNER ASSEMBLIES AND THE TOP TRACK

26 Fix in place by screwing 30mm PVCu screws into the pre-drilled holes along the bottom track.

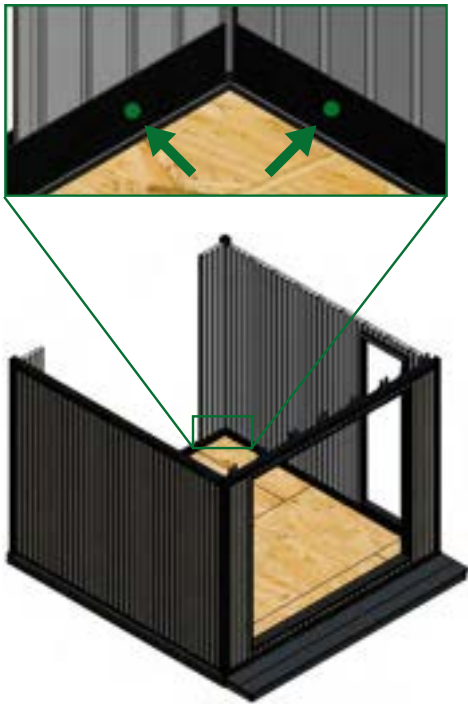

27 Find the top track that corresponds with the completed wall according to paperwork (GRD006). Run two continuous beads of adhesive along the entire length of the top track.

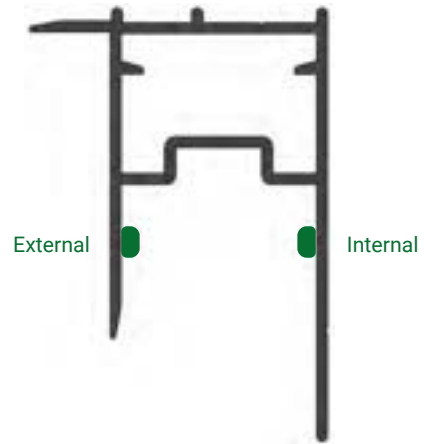

28 Install the top track using the rock and engage motion and use a rubber mallet to knock the track down. Ensure the top track is flush with the corner moulding.

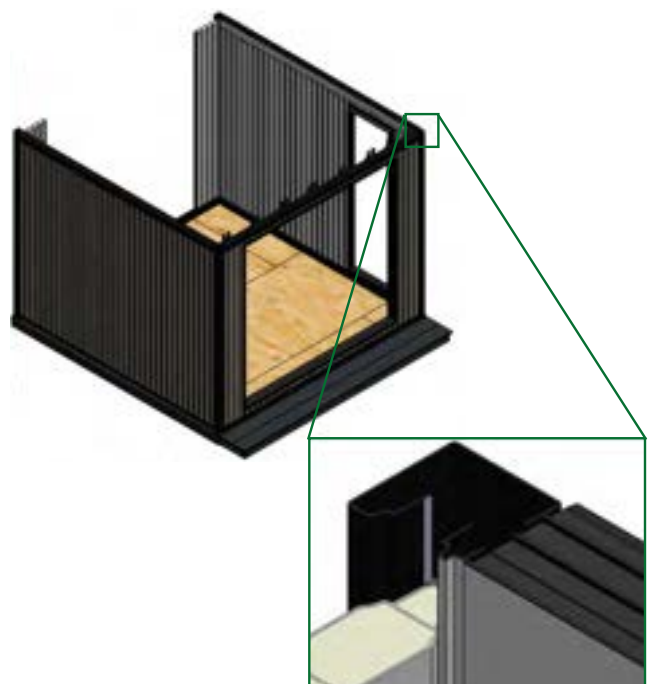
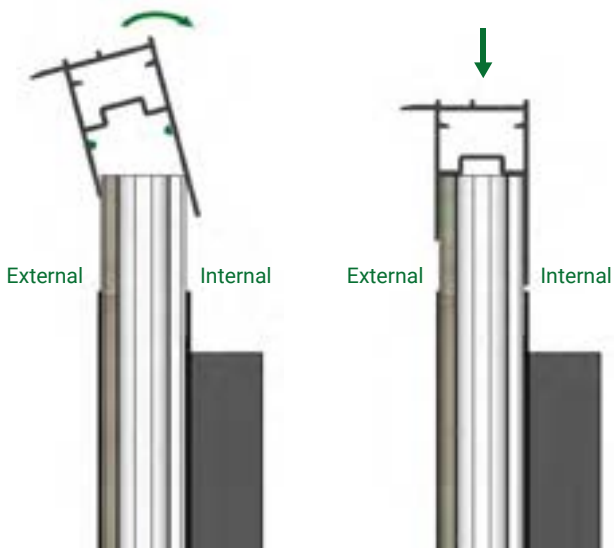



E FIXING OPENING SURROUNDS

29 Secure the opening surround in place by screwing into pre-drilled holes. Use 100mm bay pole screws in the walls and 140mm self-tapping screws into the top and bottom of the opening surround.

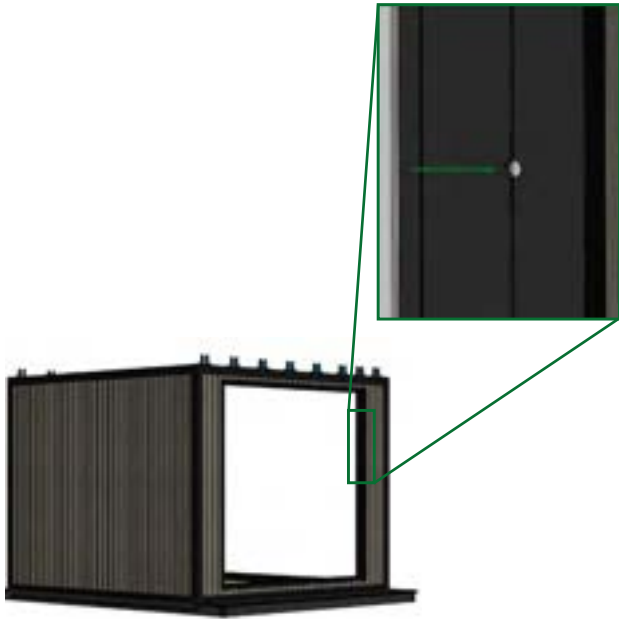

30 Ensure the formers are plumb, parallel and square before the adhesive sets by adjusting the screw tension.

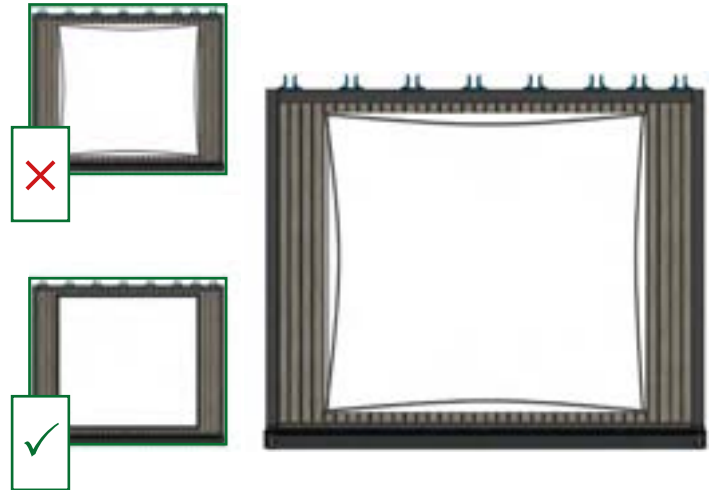

31 Seal up all holes and mitres using adhesive.

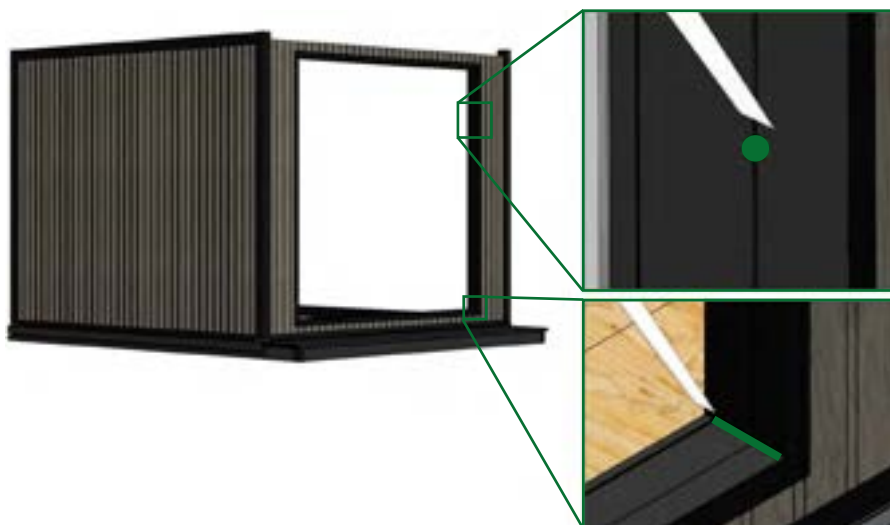



F INSTALLING THE FINAL WALL PANEL

32 To install the final wall panel, tilt the perpendicular wall outwards as much as possible.



33 Slide the final wall panel into position, making sure it engages with the panel clips.

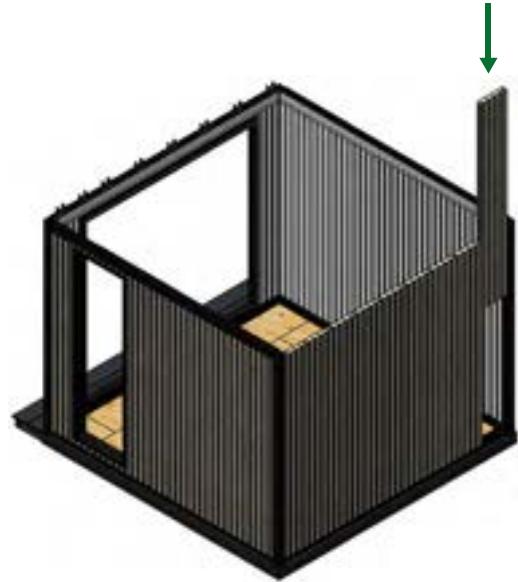

34 Insert panel clips to the top of the wall panel.

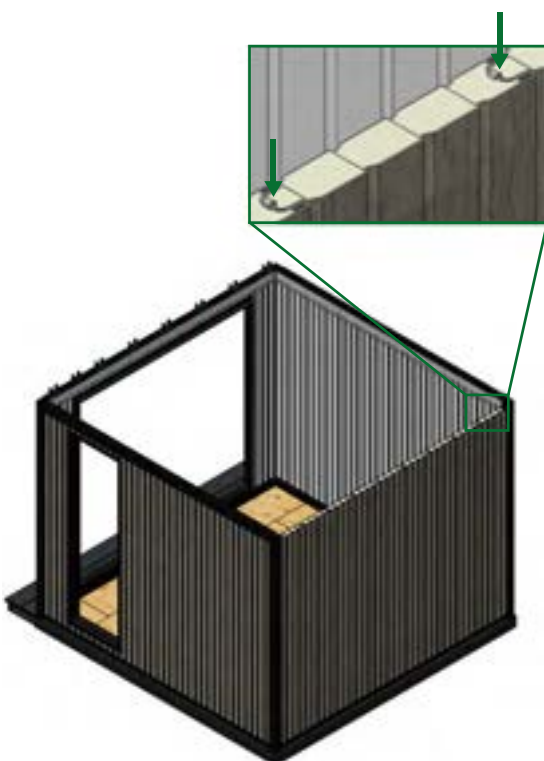

To install the top track, see page 21.
(D Installing the Secondary Corner Assemblies and the Top Track)



ROOF JOISTS



TOOLS

- Impact driver/drill
- Pz2 bit
- 13mm spanner
- Rubber headed mallet
- 10mm hex bit
- 8mm drill bit

COMPONENTS

- Central roof joists
- Roof joist ladders
- Roof joist brackets
- 5.5 X 45mm self-drilling screws
- M8 x 80mm hex bolts
- M8 nuts
- 5 X 50mm wood screws

STEP 8

INSTALLING ROOF JOISTS

1 Loosely attach roof brackets onto the roof joist ladder noggings, according to paperwork (GRD007).

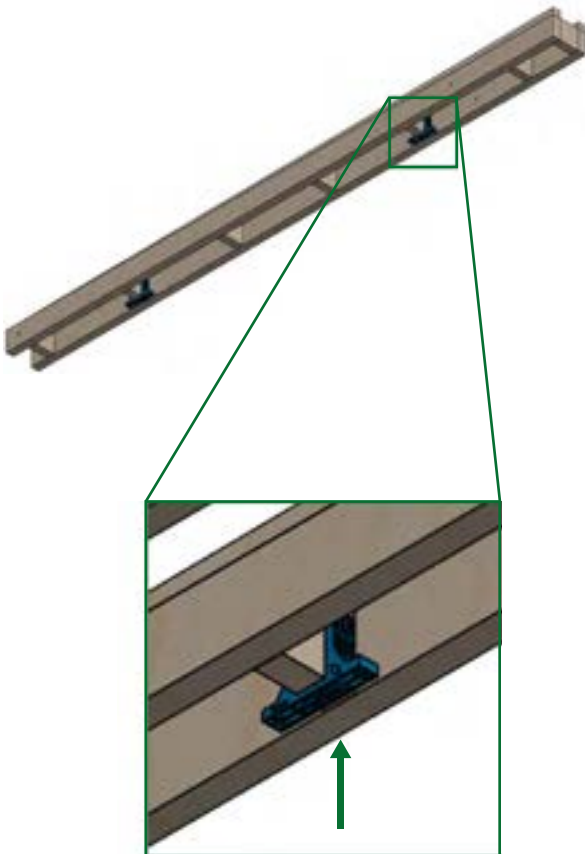

2 Slot the first roof joist ladder into the front and back brackets. Ensure the holes on the joists are aligned with those on the brackets.

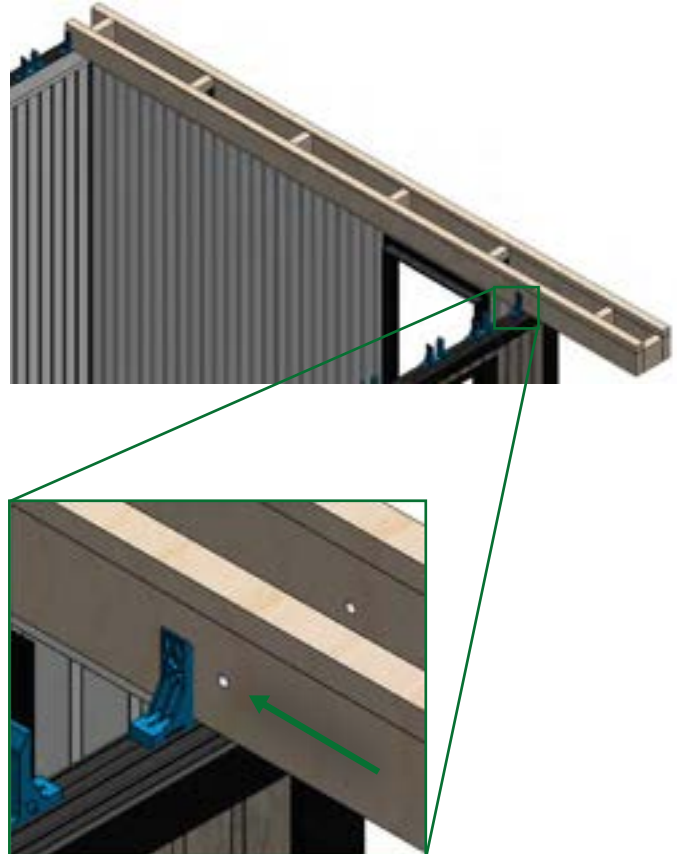



ROOF JOISTS

- 3** Position side brackets into the track between the two inner pips.

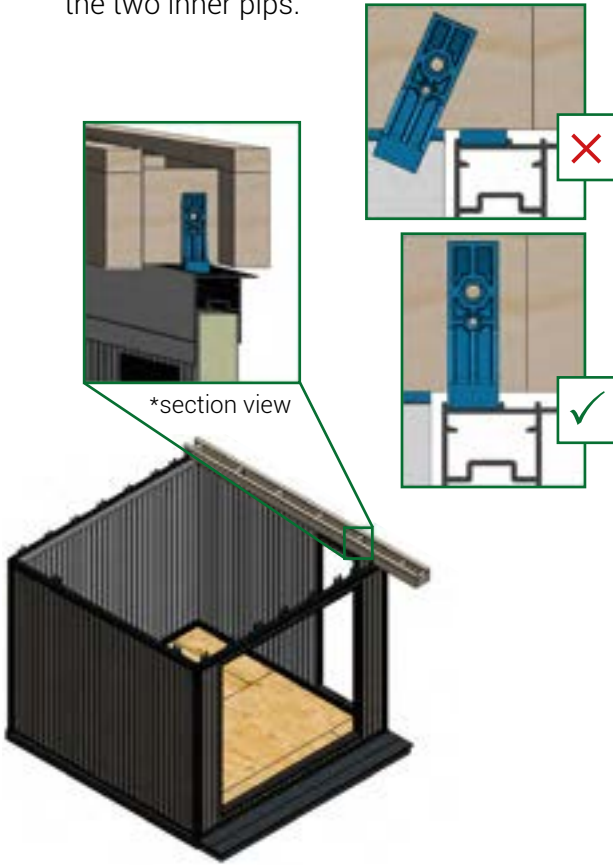

- 4** Bolt into position at the front and back of the building using M8 x 80mm bolts and nuts.

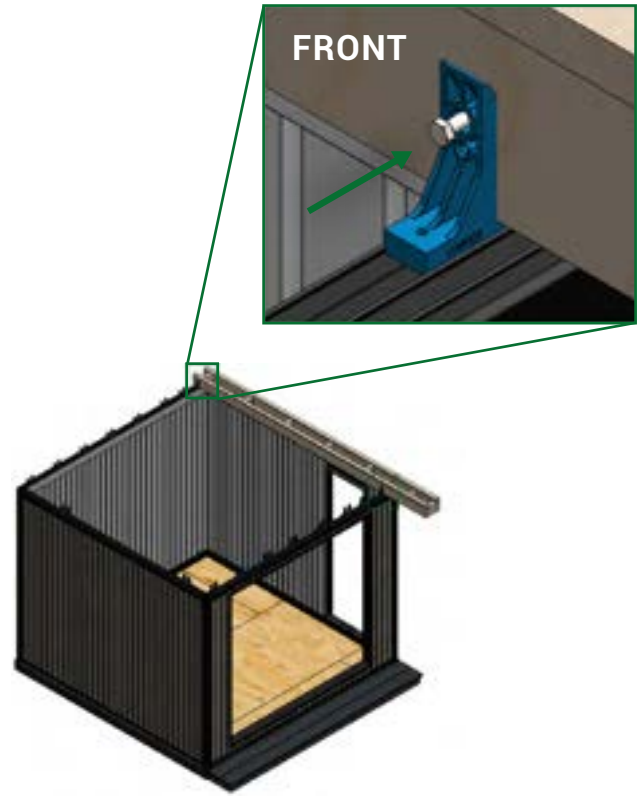

- 5** Screw brackets into noggings using 5 x 50mm wood screws into the bottom hole of the roof joist bracket.

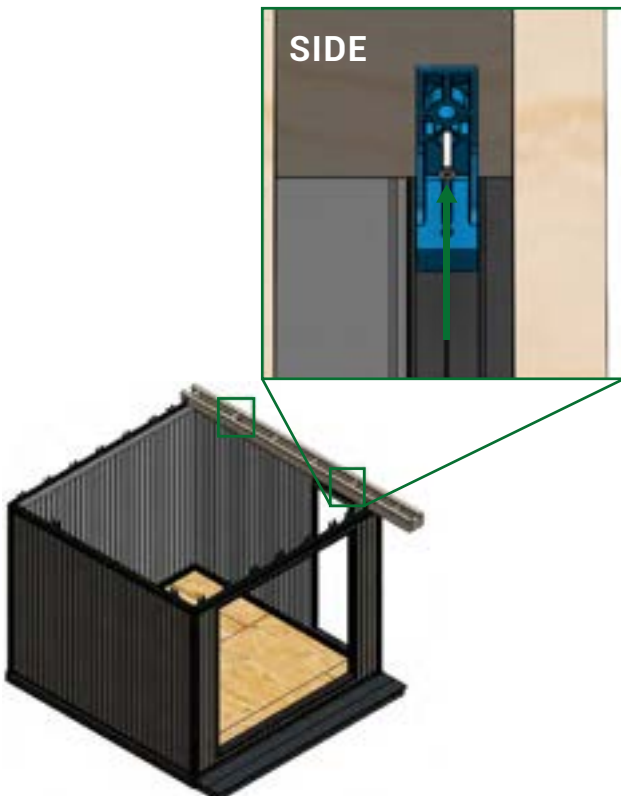

- 6** Screw brackets into the top track using 5.5 x 45mm self-drilling screws on both sides of the bracket.

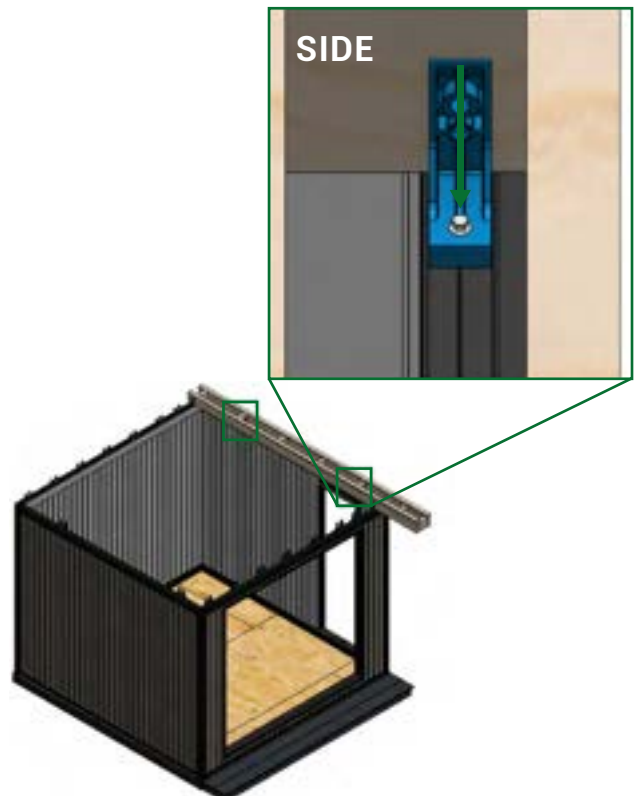



ROOF JOISTS

- 7 Repeat steps as shown before to install the second roof joist ladder.



- 8 Take a series of measurements from the back top track to the front top track. Measurements 1 and 2 should be around the same.



- 9 Slot the first central roof joist into the centremost front and back brackets, ensuring the hole on the front of the joist is aligned with the hole on the bracket.

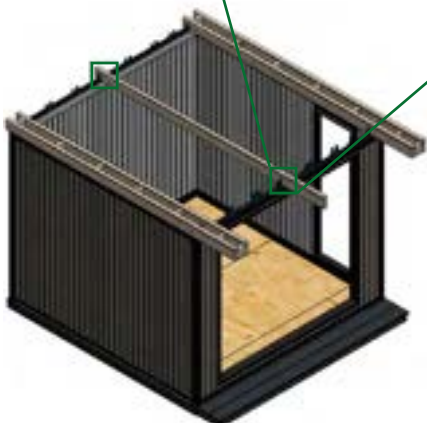

- 10 Bolt into position at the front of the building using an M8 x 80mm bolt and nut.

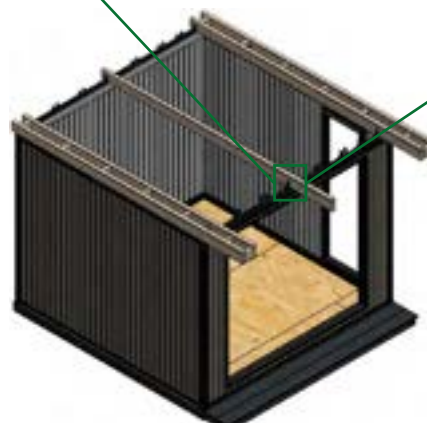
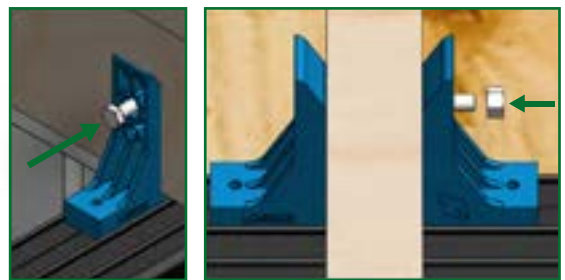



ROOF JOISTS

- 11** Pull the walls together towards the centre to match measurement 3 with measurements 1 and 2. Pin the joist in place through the rear roof bracket joist using 3mm x 30mm wood screw.

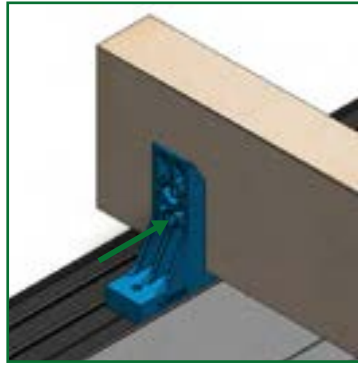

- 12** When aligned, run an 8mm hole through the back roof joist and bolt into position with an M8 x 80mm bolt and nut.

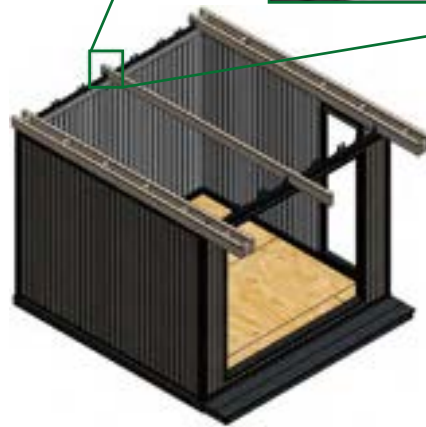
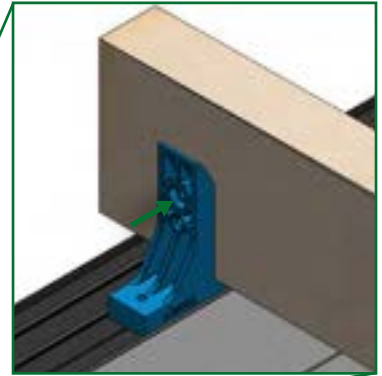

- 13** Fit the rest of the central roof joists.



If you have a double door with sidelights, you must install it at this point. See page 45 for instructions (B Double Door with Sidelight).



DRAINING EDGE FASCIA



TOOLS

Impact/drill

Hammer

Pz2 bit

COMPONENTS

150mm fascia

Trim gutter edge backplate

PVCu nails

5mm x 50mm screws

STEP 9

INSTALLING THE DRAINING EDGE FASCIA

- 1 Position the 150mm fascia onto the back edge of your roof by pushing the fascia up to the lintel tongue.

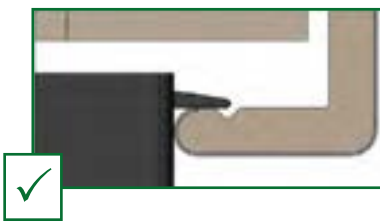
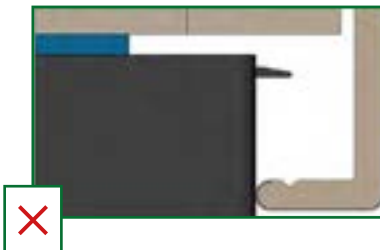

- 2 Centralise and fix in place using a PVCu nail into every joist. Ensure these nails are positioned 30mm from the bottom edge of the fascia to ensure there is space for the gutter edge trim.

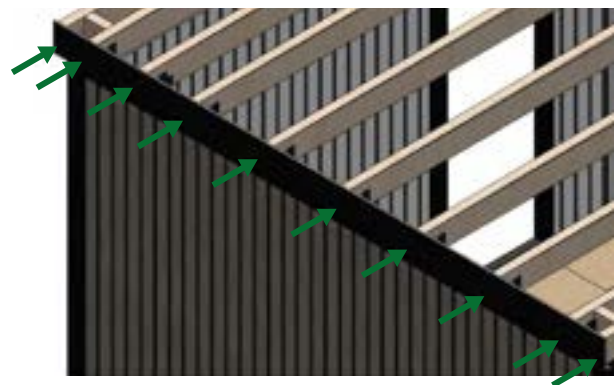
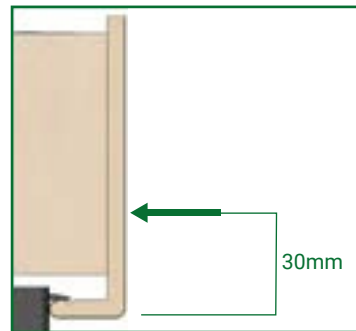



DRAINING EDGE FASCIA

- 3 Install the trim gutter edge backplate using 5mm x 50mm screws into every joist. The top of the gutter edge backplate should be flush with the top of the fascia, and it should be set in by 30mm on each side.

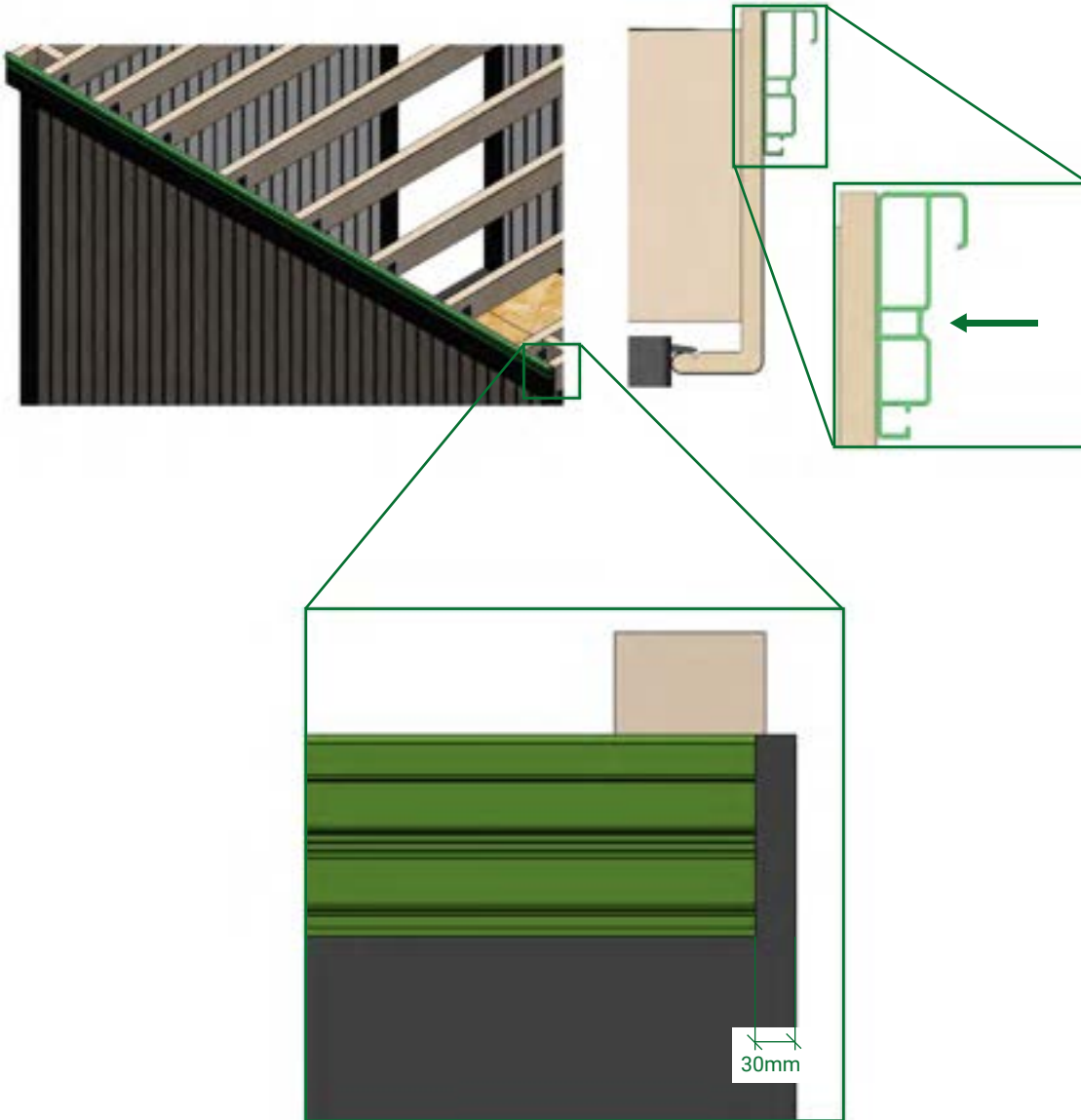



ROOF OSB



TOOLS

Impact driver/drill
Pz2 bit
Ladder

COMPONENTS

Roof OSB (R*)
5 X 50mm wood screws

STEP 10 FIXING DOWN OSB

- 1 Lay out your first sheet of OSB on top of the roof joists according to paperwork (GRD008).



- 2 Fix down OSB using 50mm wood screws at 600mm centres and into all joists. Fix around the perimeter of the board too.

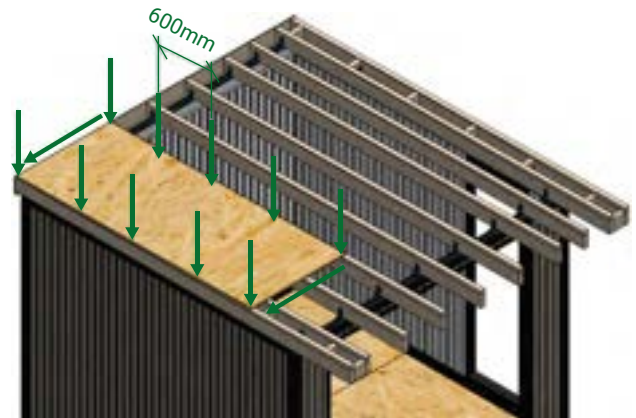

NOTE: You can use stringline to show the position of the joists.

- 3 Repeat this process for the rest of the roof OSB.





ROOF MEMBRANE



TOOLS

Roller/paintbrush –
long handle

Soft-bristled broom

Trimming knife

COMPONENTS

Rubber roof
membrane

Membrane adhesive

STEP 11

LAYING DOWN ROOF MEMBRANE

- 1 Lay out your roof membrane on top of the roof and let it relax, so that any creases and folds are smoothed out. The OSB must be dry before you begin to allow the adhesive to set properly.



TIP: We recommend that you give the membrane as much time as possible to relax, such as overnight, particularly on colder days.

- 2 Fold one quarter of the roof membrane back over itself, and then another quarter.





ROOF MEMBRANE

- 3 Apply the membrane adhesive to the first quarter of the roof OSB



- 4 Lay the membrane onto the adhesive. This can be done by rolling it out to avoid stress and wrinkles. Entrapped air and wrinkles can be removed by gently smoothing with a soft bristle broom.



- 5 Apply adhesive to the next quarter of the roof and repeat the above steps.



- 6 Roll back the other half of the roof membrane using the same quarters method. Repeat the adhering process to complete the roof membrane.





EDGE TRIMS



TOOLS

Impact driver/drill

Pz1 bit

PVC saw

Silicone gun

COMPONENTS

Edge trim

3mm x 30mm screws

Adhesive

Gutter edge backplate

STEP 12

INSTALLING EDGE TRIMS

- 1 Start with the front trim – this should cover the full width of the roof. Seal the underside of the trim with adhesive and pin into place using 3mm x 30mm screws.

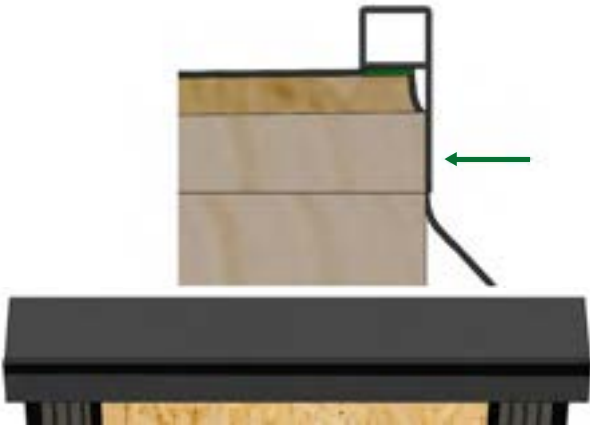

- 2 The side trims should butt up to the front trim and be flush to the back edge. Seal the underside of the trim with adhesive and pin into place using 3mm x 30mm screws.



NOTE: Leave excess rubber overhanging.

- 3 Seal between all the gaps in the trims using adhesive.





EDGE TRIMS

4 Trim the excess rubber along the back edge through the groove shown below.

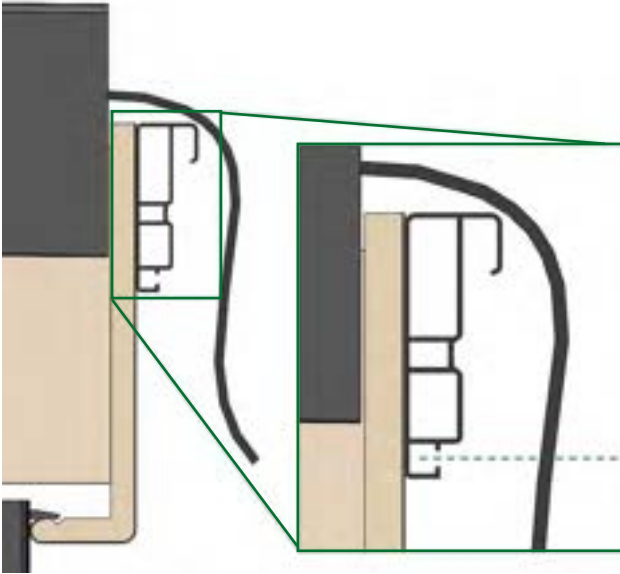

5 Tuck excess rubber along the back edge into the gutter edge backplate and clip the gutter edge plate into place.



A Push the rubber up tight

B Use a nylon mallet to tap the trim into the clip.

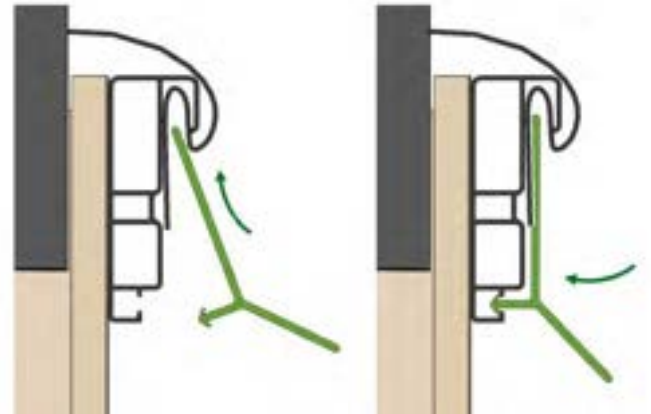

6 Find the Edge Trim Corner Mouldings and apply superglue to the inner faces.



7 Offer the moulding to the corner where the edge trims meet and allow it to adhere.

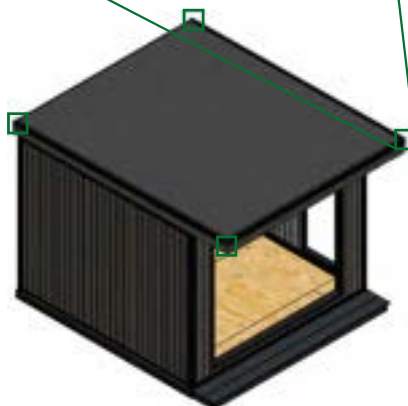

8 Trim the rest of the roof membrane so that it is level with the bottom edge of the roof joists.



TIP: You can mark the position of the joists with chalk for later use.



SOFFITS



TOOLS

Impact driver/drill

Pz1 bit

COMPONENTS

Soffits

H-Trim
(see paperwork if applicable)

3mm x 30mm screws

STEP 13

INSTALLING SOFFITS

Only applicable to Canopies

- 1 Consult paperwork (GRD007) to find which joist to install the H-Trim onto. The longer soffit board will always be positioned on the left.

- 2 Screw the H-Trim into place using 3mm x 30mm wood screws at 300mm centres.

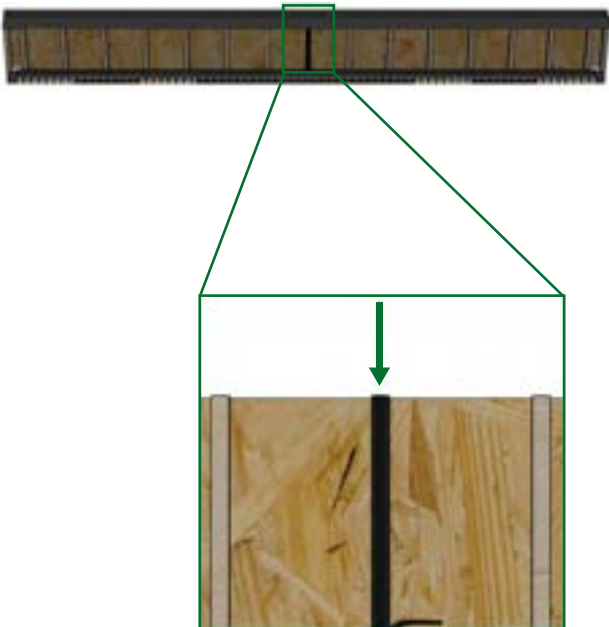

NOTE: Make sure screws are flush with the H-Trim.



SOFFITS

- 3 Slot the soffit board into the top track tongue and side H-Trim.

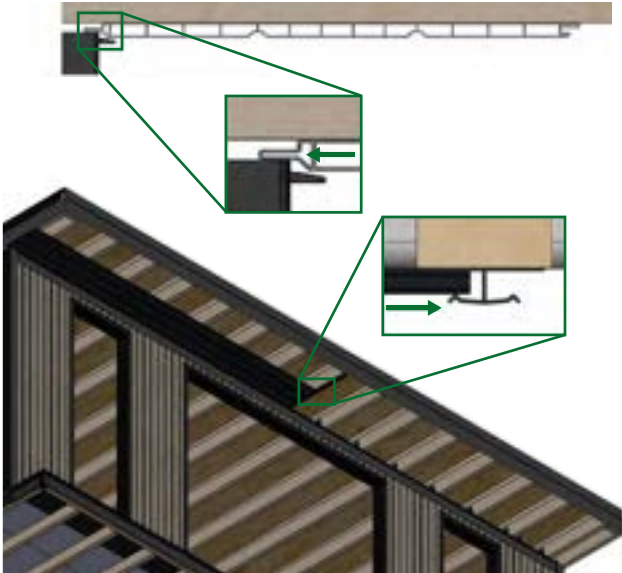

- 4 Screw in place along the tongue detail and into every joist with 3mm x 30mm screws, making sure all screw heads are flush with the tongue.

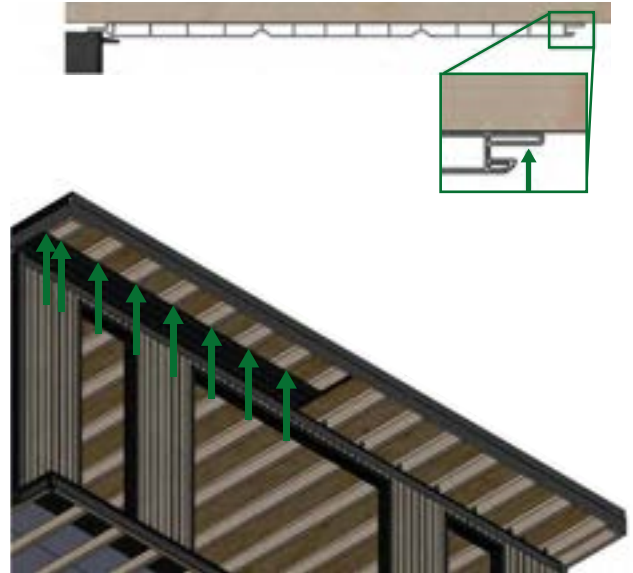

NOTE: Ensure your screws are straight, to prevent the connecting board from catching.

- 5 Repeat for the next soffit board.

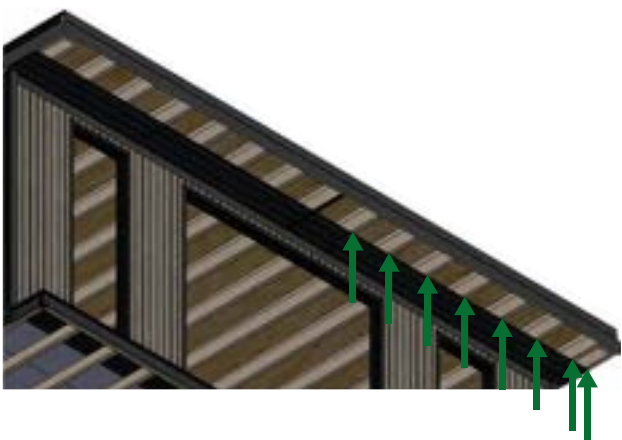

- 6 Slide the next board into position and fix along the lip into every joist.

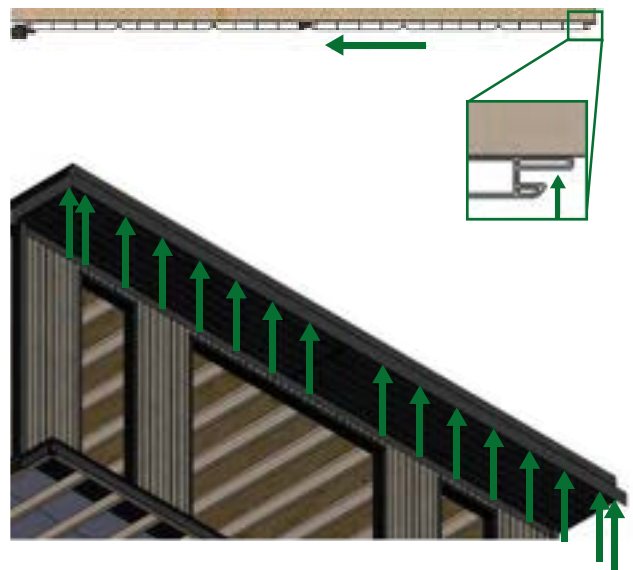



FASCIA



TOOLS

PVC saw

Hammer

COMPONENTS

Fascia

Fascia inline
moulding

H-Trim

PVCu nails

Superglue and
activator

STEP 14 INSTALLING FASCIA

- 1 Apply adhesive to the edge trim

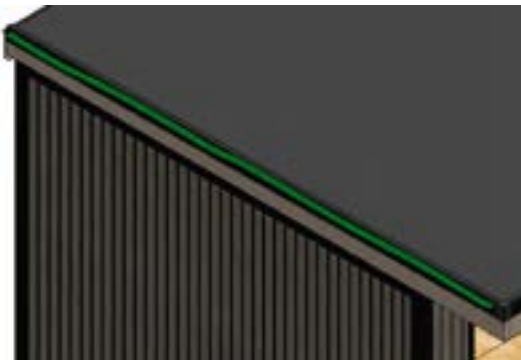

NOTE: You can mark the position of the joists with chalk on the edge trims.

- 2 Offer the fascia to the side of the building and centralise. Make sure the fascia is pushed up to the tongue on the top track.

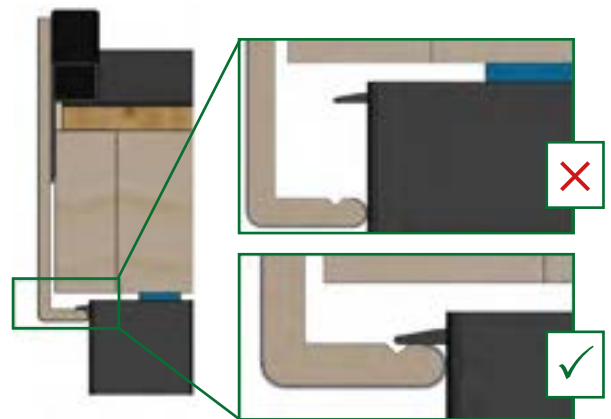

NOTE: Trimming or notching may be required at corners.



FASCIA

- 3** Fix the fascia into place using black PVCu nails at 400mm centres, ensuring the nails always locate into the joists. The front fascia will need to be fixed into the joist ends.

Leave the heads of the PVCu nails a couple of mm shy of the fascia, to ensure the Pro Tape can be removed cleanly. Once the Pro Tape has been removed, these can be tapped in all the way.

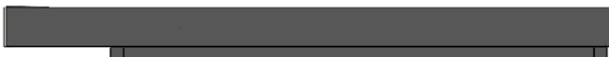

TIP: You can use the Pro Tape on the fascia as a guide to position the PVCu nails. The dots on the Pro Tape are spaced 100mm apart.

- 5** Where the two fascias meet, use superglue to glue the trim over the joint.



NOTE: In cases where the fascia is 5m or longer, the Inline Fascia Trim must be installed.

- 4** Repeat process for the rest of the fascias.

- 6** Apply superglue to the inside face of the fascia corner moulding. Offer up to the building and let it adhere.

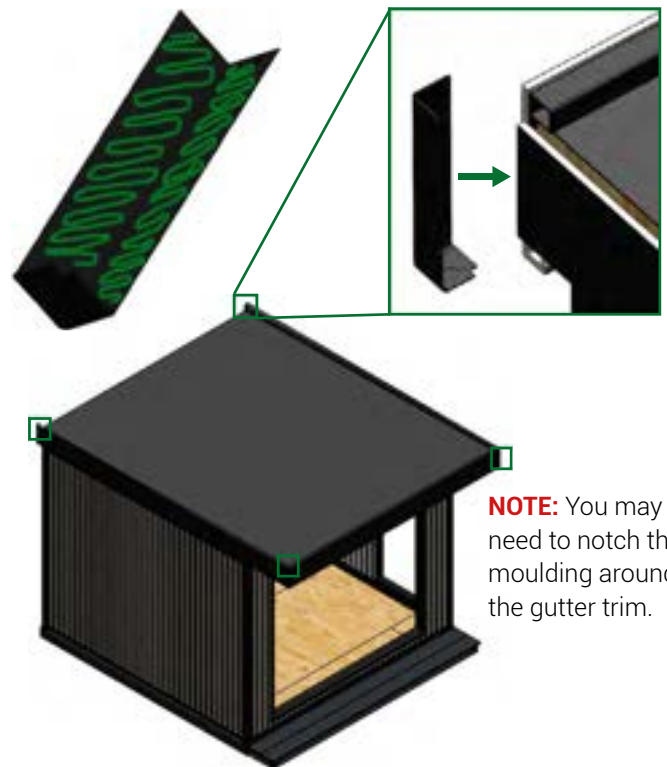

NOTE: You may need to notch the moulding around the gutter trim.



WINDOWS AND DOORS



TOOLS

Impact driver/drill

Ph2 bit

5mm drill bit

Silicone gun

Safety knife

Glazing shovel

Nylon hammer

Spirit level

Putty knife/chisel

COMPONENTS

Adhesive

Black silicone

TruFit tape

80mm bay pole screws

50mm PVC screws

Superglue

Glazing packers

Windows and doors

STEP 15

INSTALLING WINDOWS AND DOORS

For best practice when installing windows and doors into your garden room, please consult BS8213-14.

- 1 Remove the screws from all dummy sashes inside to allow it to unhinge.



- 2 To prepare for the TruFit tape, clean the sides of the frame.

- 3 TruFit is fixed to the outside edges of the frame before the window is installed. The tape should be set back 2mm from the external face of your window frame.

Remove the backing tape and stick the tape to the frame. Ensure the white edge of the tape is facing toward the inside white face of the frame.

TruFit should be folded over itself at all corners, to allow for extra expansion.

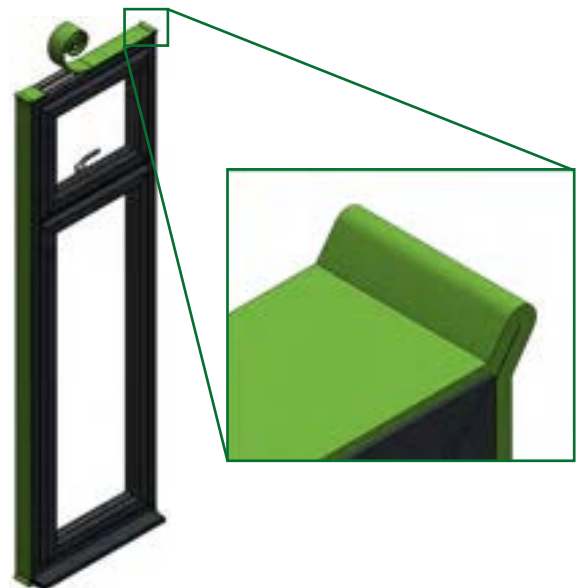

NOTE: Install the tape onto one window/door at a time, as the foam starts expanding as soon as it is unrolled. Work quickly when installing TruFit tape.



WINDOWS AND DOORS

- 4 Push the frame into the opening surround, ensuring it is up to the back stop.

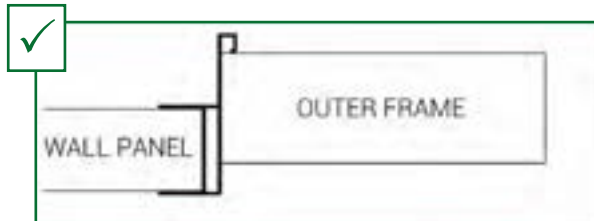
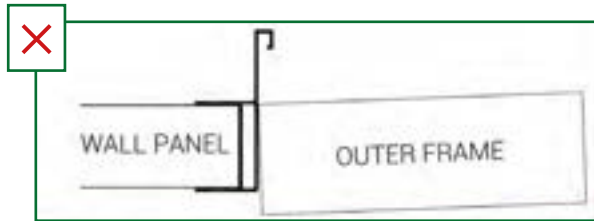

- 6 Seal all fixing holes.



- 5 Double check that the frame is square. Then fix the frame in place using 80mm bay pole screws through the sides of the frame, at 150mm from the corners and at 600mm centres.

Screw through Pre-Drilled Holes

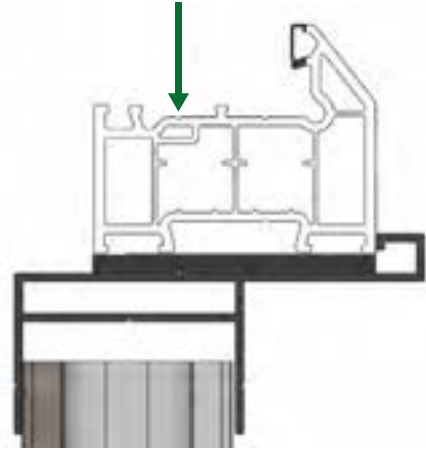

NOTE: A double door requires being fixed in the top and bottom of the frame as well as the sides. This should be done at 150mm from the corners of the frame and at 600mm centres.

NOTE: Adjust screws to square up the frames.

- 7 Close and fix dummy sashes in all windows using the original screws.





WINDOWS AND DOORS

8 Clean any debris from the frame and surrounding areas before fitting the glazing.

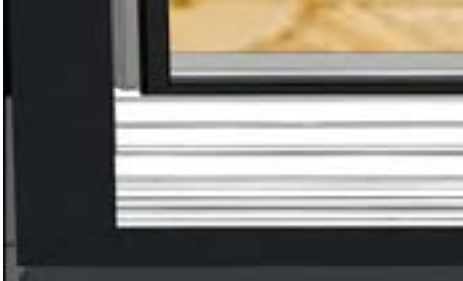

9 Remove the beads, taking note of their positions.

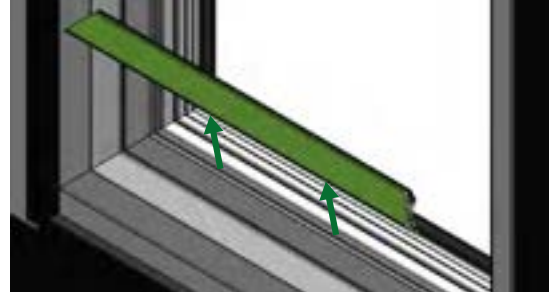

10 Clip Linair glazing platforms into place around the opening. They should be laid out accordingly depending on your window configuration:



You have a Fixed Pane

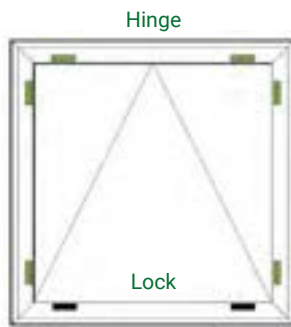

You have an Opening Window

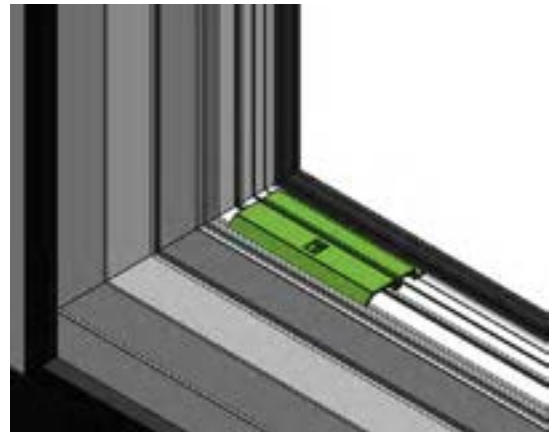

Doors will need to be 'toe and heeled' which means the glass is packed at diagonally opposing corners, at the bottom on the hinge side and top on the handle side.



Single Panelled Door



Double French Door



Double Panelled Door



WINDOWS AND DOORS

- 11** Install the glass, ensuring a tight fit against the glazing platforms. Glazing packers can be used to lift the sash to the required height by packing the opposing door corners so that the door can be squared up.

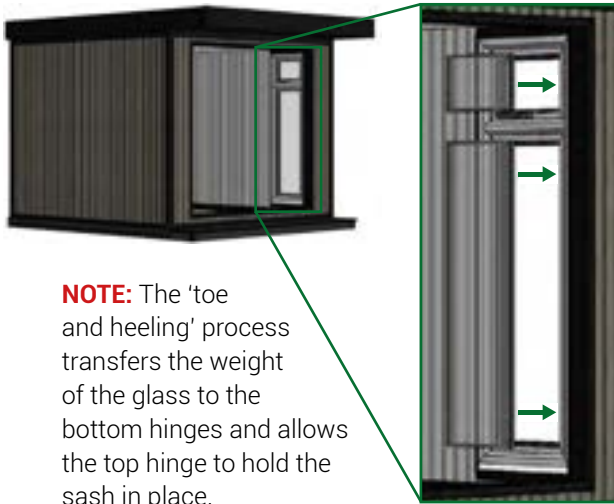

NOTE: The 'toe and heeling' process transfers the weight of the glass to the bottom hinges and allows the top hinge to hold the sash in place.

- 13** Install the beads. Always start with the smaller beads first to hold the glazed unit in place. To help locate the beads, spray glass cleaner around the edges of the glass.

Starting at the corner, locate the back of the bead into the groove and tap it gently into place with a nylon mallet, keeping pressure against the glass. Start from the edge and work towards the middle.

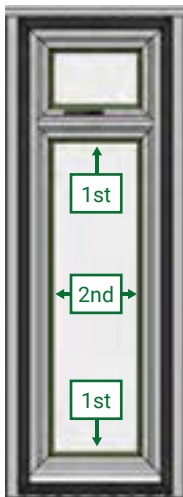
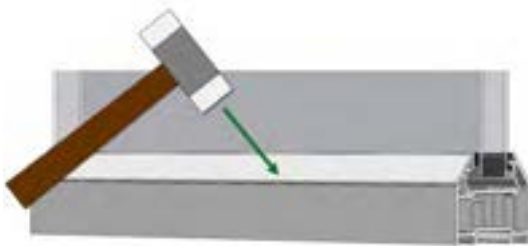

NOTE: Hinges may need to be adjusted on doors.

- 12** Make sure that the glass unit is pushed right back into the glazing seal by using a glazing shovel.

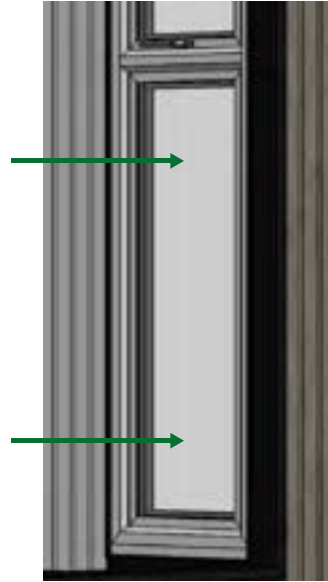

- 14** Run a continuous bead of black silicone around the perimeter of all your windows and doors.

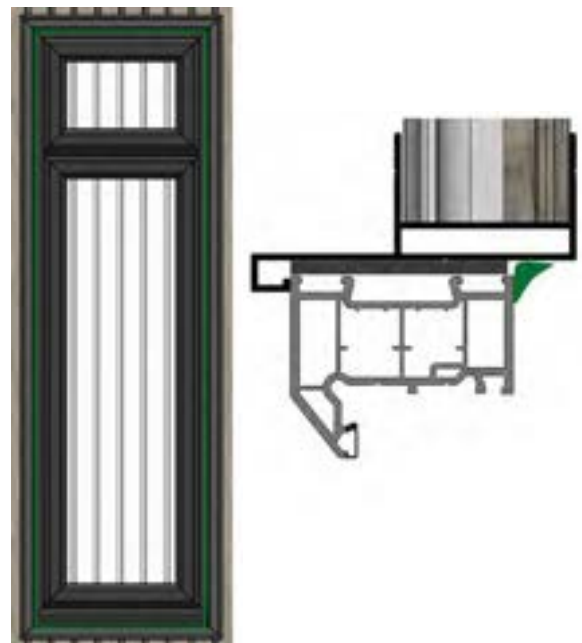



A SINGLE DOOR WITH SIDELIGHT

- 15** Clip the two butt joint trims into position as shown below – the inner-facing clip into the door, and the outer-facing clip into the sidelight.

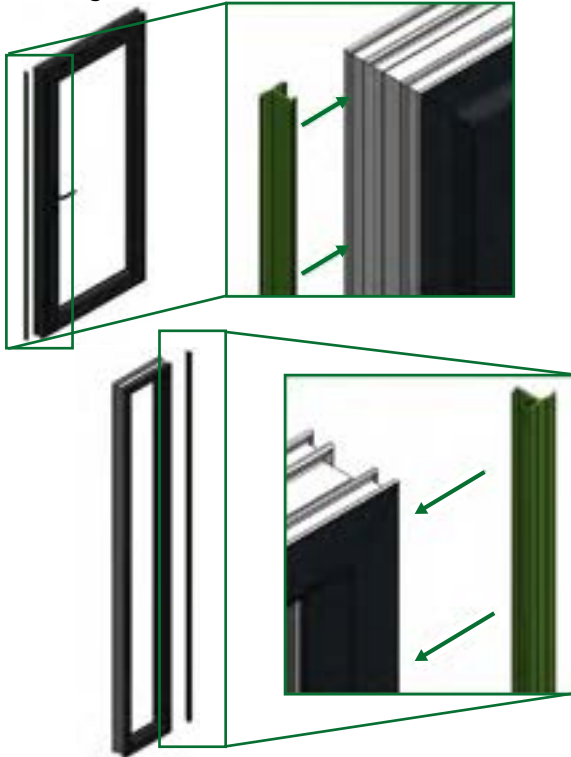

- 16** Run a bead of adhesive down the flat edge of the butt joint trims.

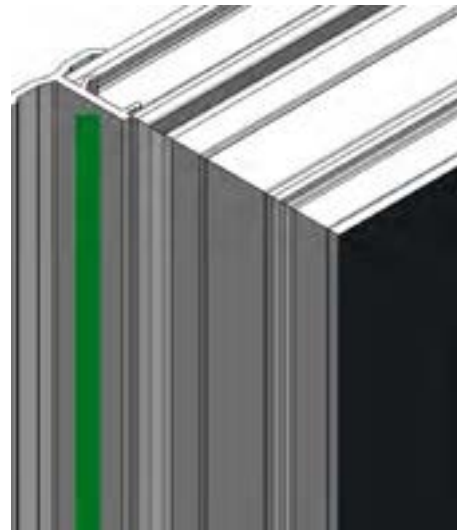

- 17** Push the two frames together, and then open the door to fix through both sides of the door and sidelight using 60mm PVCu screws at 600mm centres.



Follow the instructions starting from page 40 onwards to install your door. (Step 15: Installing Windows and Doors). Please keep in mind that you may have to notch the butt joint trim to accommodate the back stop on the opening surround.



B DOUBLE DOOR WITH SIDELIGHTS

18 Clip your frames together using the aluminium butt joints.

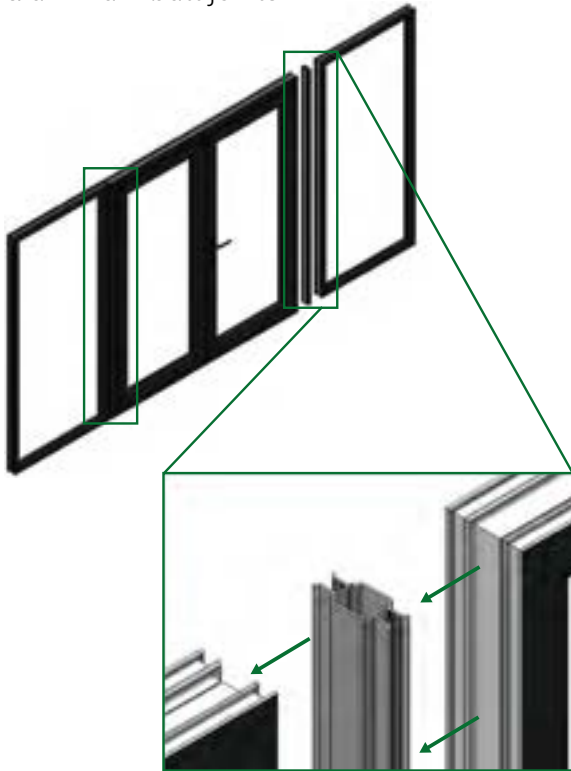

20 Clip the four trims into the aluminium butt joints as shown below.

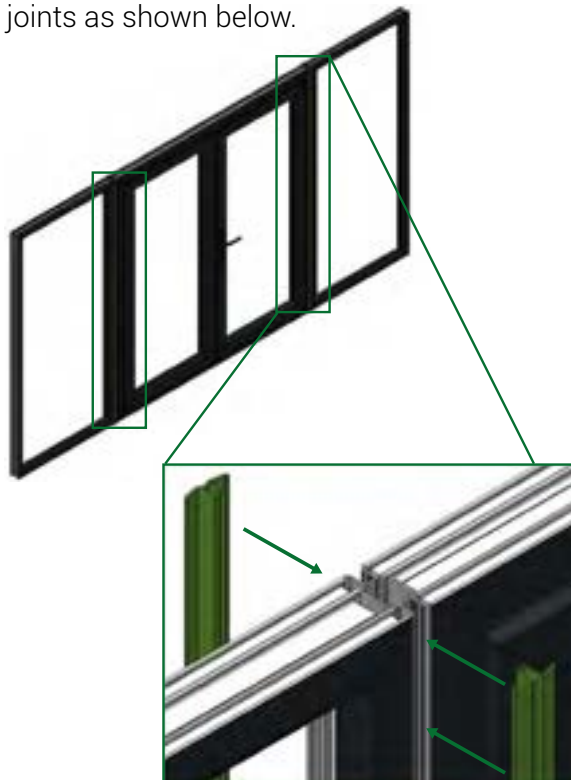

19 Open the doors to fix through both sides of the door and sidelight, using 80mm PVCu screws at 600mm centres.

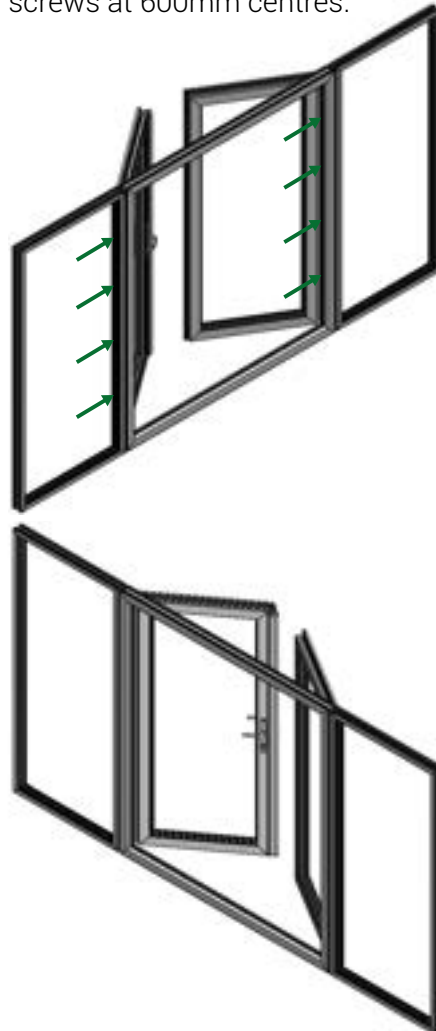

Follow the instructions starting from page 40 onwards to install your door. (Step 15: Installing Windows and Doors)

Please keep in mind that you may have to notch the trims to accommodate the back stop on the opening surround.

Once you have installed your double door with sidelights, you can resume your installation from page 25.

(Step 8: Installing Roof Joists)



Scan the QR code for more information regarding how to install and glaze our windows.



FLOOR INSULATION



TOOLS

No tools required

COMPONENTS

Insulation tape

Floor insulation (I*)

STEP 16

LAYING DOWN FLOOR INSULATION

- 1 Lay down floor insulation according to the paperwork (GRD009).

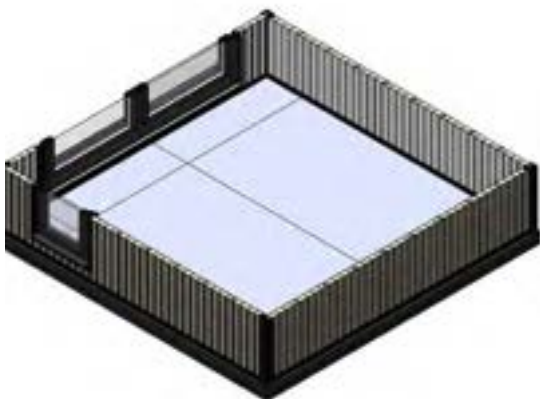

- 2 Seal all joints with insulation tape.





FLOORBOARDS



TOOLS

Hammer

Block of wood

COMPONENTS

Floorboards (F*)

STEP 17

LAYING DOWN FLOORBOARDS

- 1 Lay down floorboards according to the paperwork (GRD010). No fixings or adhesive are required. Ensure they are in the correct orientation for tongue and grooves to locate together. Ideally start underneath a door and finish on a blank wall.

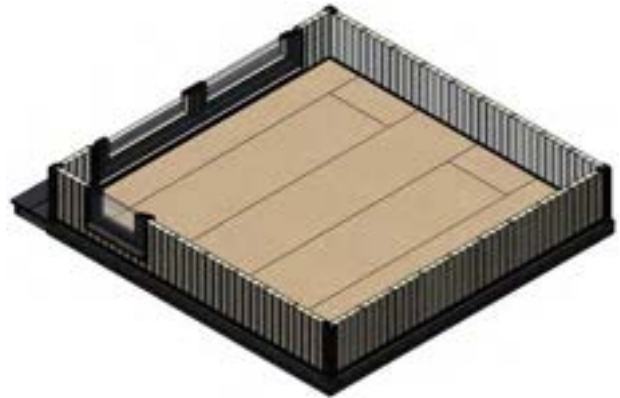
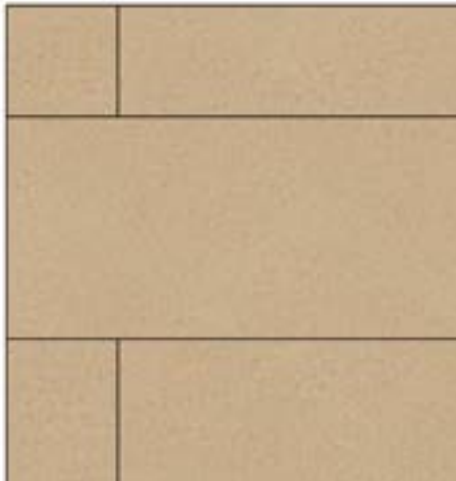

NOTE: Trimming may be required to fit your final panel.



CEILING INSULATION



TOOLS

No tools required

COMPONENTS

Ceiling insulation

STEP 18

INSTALLING CEILING INSULATION



1 It is important before the installation of the ceiling insulation that the proper PPE is worn, for your health and safety.

- Safety glasses with side shielding
- Protective gloves, long sleeves and long trousers
- Ensure proper ventilation, and wear a dust respirator
- Wash hands and all clothes after handling the insulation.

2 Stuff the ceiling insulation into the joist cavities.

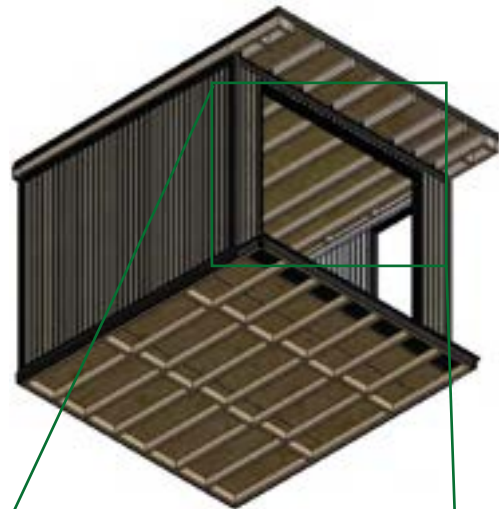

NOTE: There should be a 50mm gap between the insulation and the roof OSB.



CEILING PANELS



TOOLS

Impact driver/drill

Pz1 bit

Straight edge

Knife

Tape measure

Nylon hammer

COMPONENTS

3mm x 30mm screws

Ceiling trim

Ceiling panels

H-Trim

Adhesive

STEP 19

INSTALLING CEILING PANELS

(Only applicable for ceilings over 3m)

- 1 H-Trim is required here. Fix H-Trim into position according to paperwork (GRD011), at 600mm centres into the joist.



- 2 Cut the first panel down to size and offer it into position, ensuring the male end is butted up to the top track.

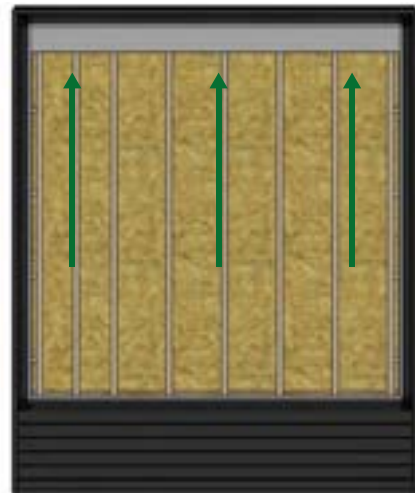

MALE END

FEMALE END





CEILING PANELS

- 3 Fix into the male end of the panel using 3mm x 30mm screws into every joist.

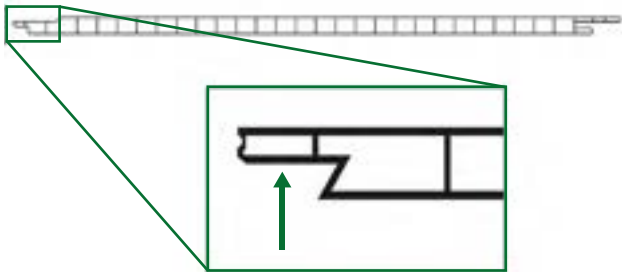
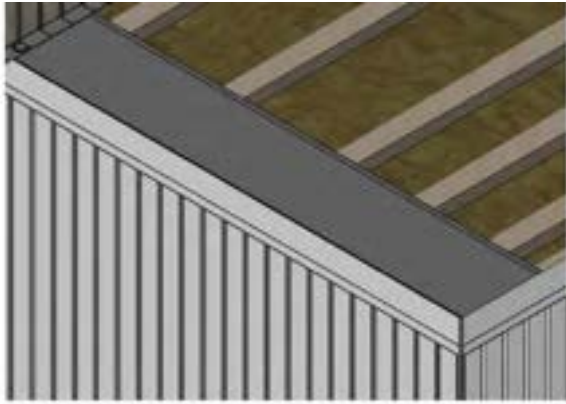

NOTE: Ensure your screws are no more than 10mm away from the wall.

- 4 Fix into the female end of the panel using 3mm x 30mm screws into every joist.

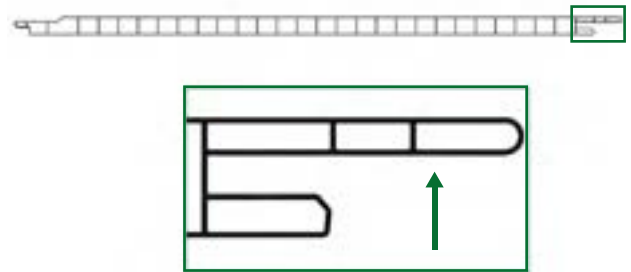
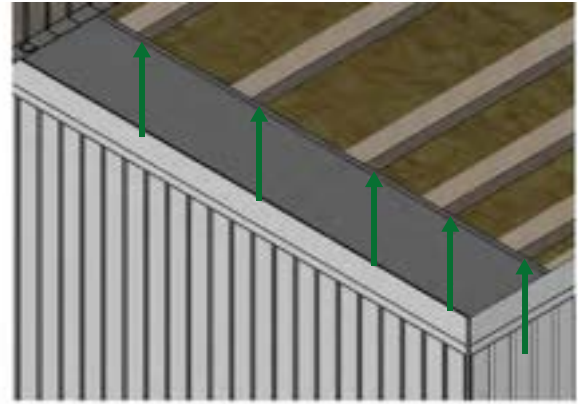

- 5 Cut down and slot the next panel into place, ensuring it is fully pushed in and there is no gap in between them. Fix into place along the female end and into every joist.

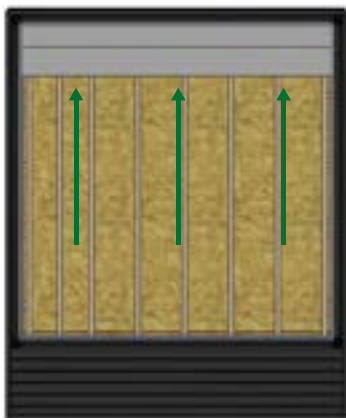

- 6 Repeat until you reach the final panel.





CEILING PANELS

- 7 Take a series of measurements of the space for your final panel.



NOTE: These measurements may be slightly out of square, so ensure both ends are checked.

- 9 Slot and pin the final panel into place.



- 12 Push the ceiling trim up to the ceiling and top track, applying pressure throughout the length. Then, hold it in position with masking tape until the silicone cures.

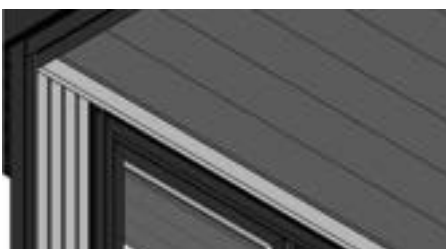
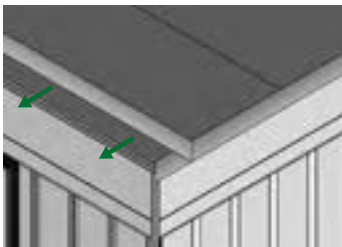

- 8 Deduct 5mm from your measurements to allow your panel to fit neatly and cut to size along the female end.

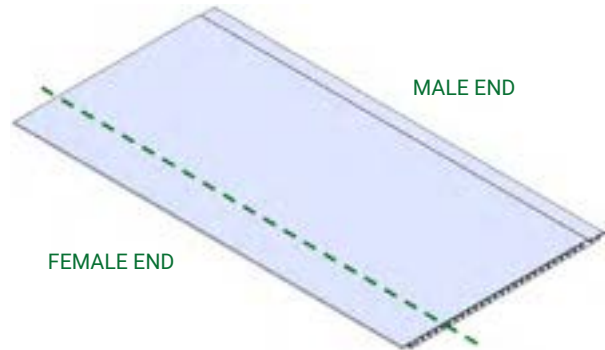

- 10 Cut and mitre your quadrant trims according to paperwork (GRD011).

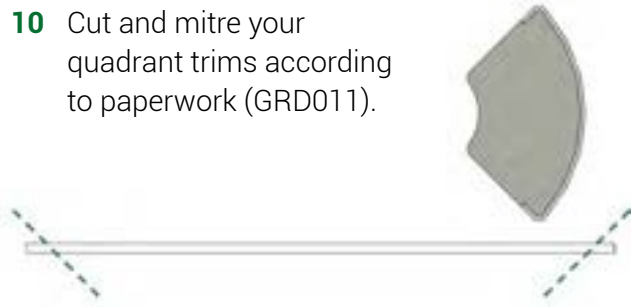

- 11 Apply adhesive to the edges shown on the quadrant trim.



- 13 Repeat until all trims are in place.

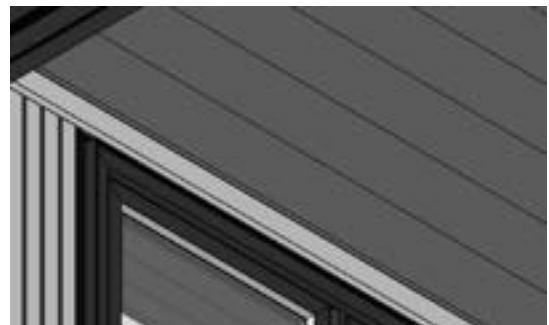

A Part of Something BiggerSM



CONTACT THE LINIAR TEAM TODAY!

T +44(0)1332 883900

E sales@liniar.co.uk

EXPLORE THE FULL LINIAR RANGE

WINDOWS | DOORS | GLAZED ROOFS | DECKING | FENCING | PILING

LINIAR.CO.UK

